

ECT and AT Indicator <1AR-FE> , Engine Control <1AR-FE>

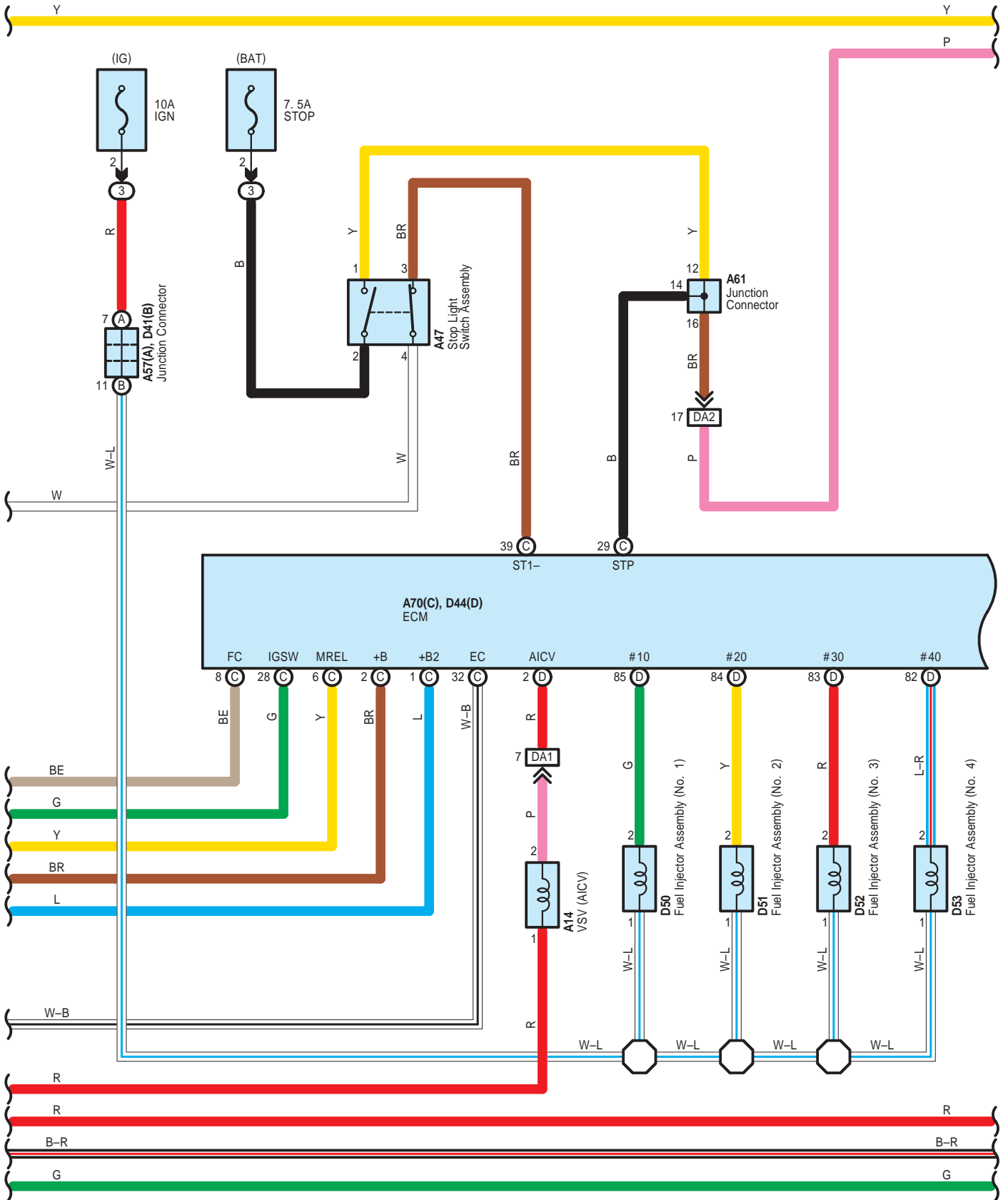

ECT and AT Indicator <1AR-FE> , Engine Control <1AR-FE>

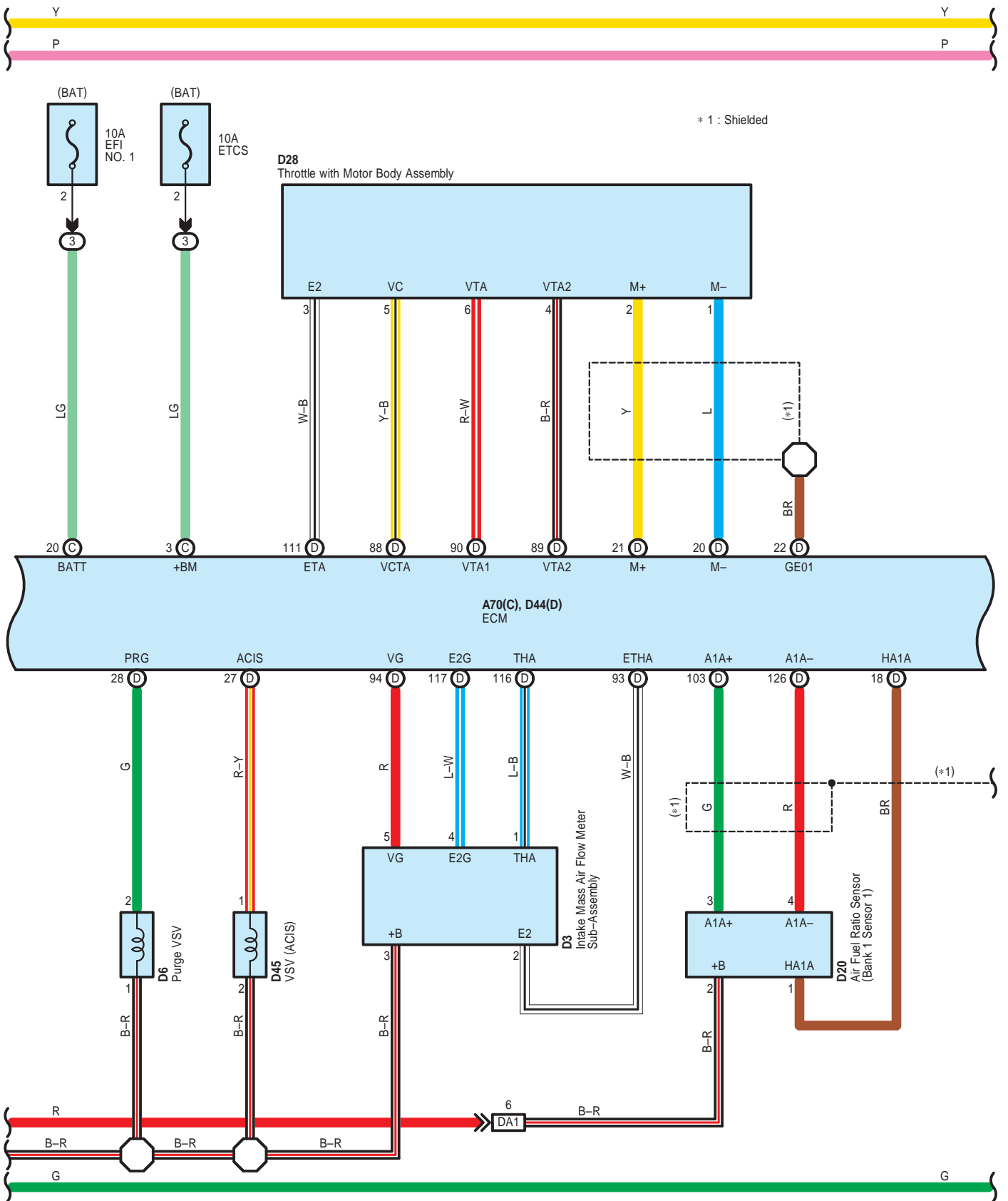

ECT and AT Indicator <1AR-FE> , Engine Control <1AR-FE>

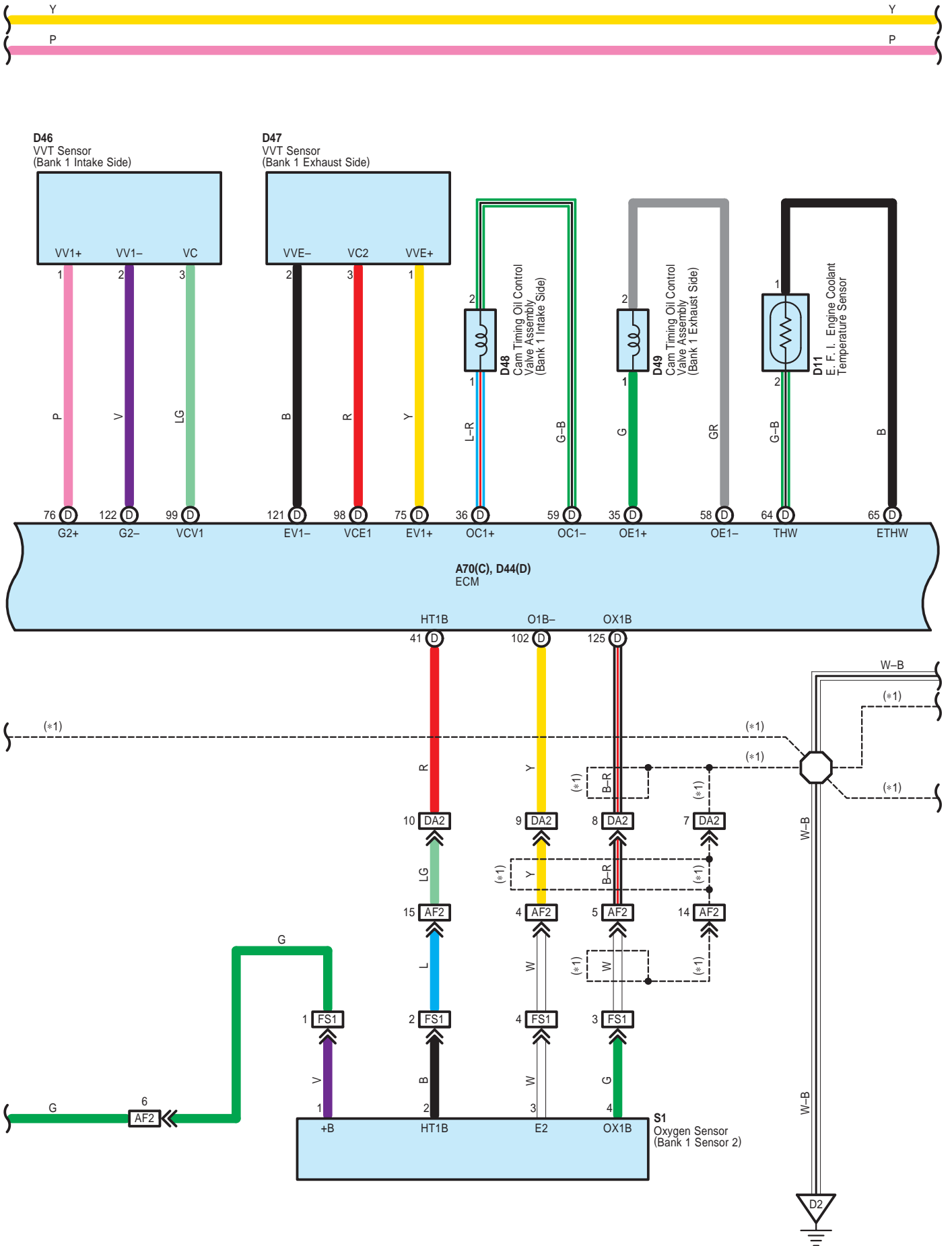



\* 1 : Shielded

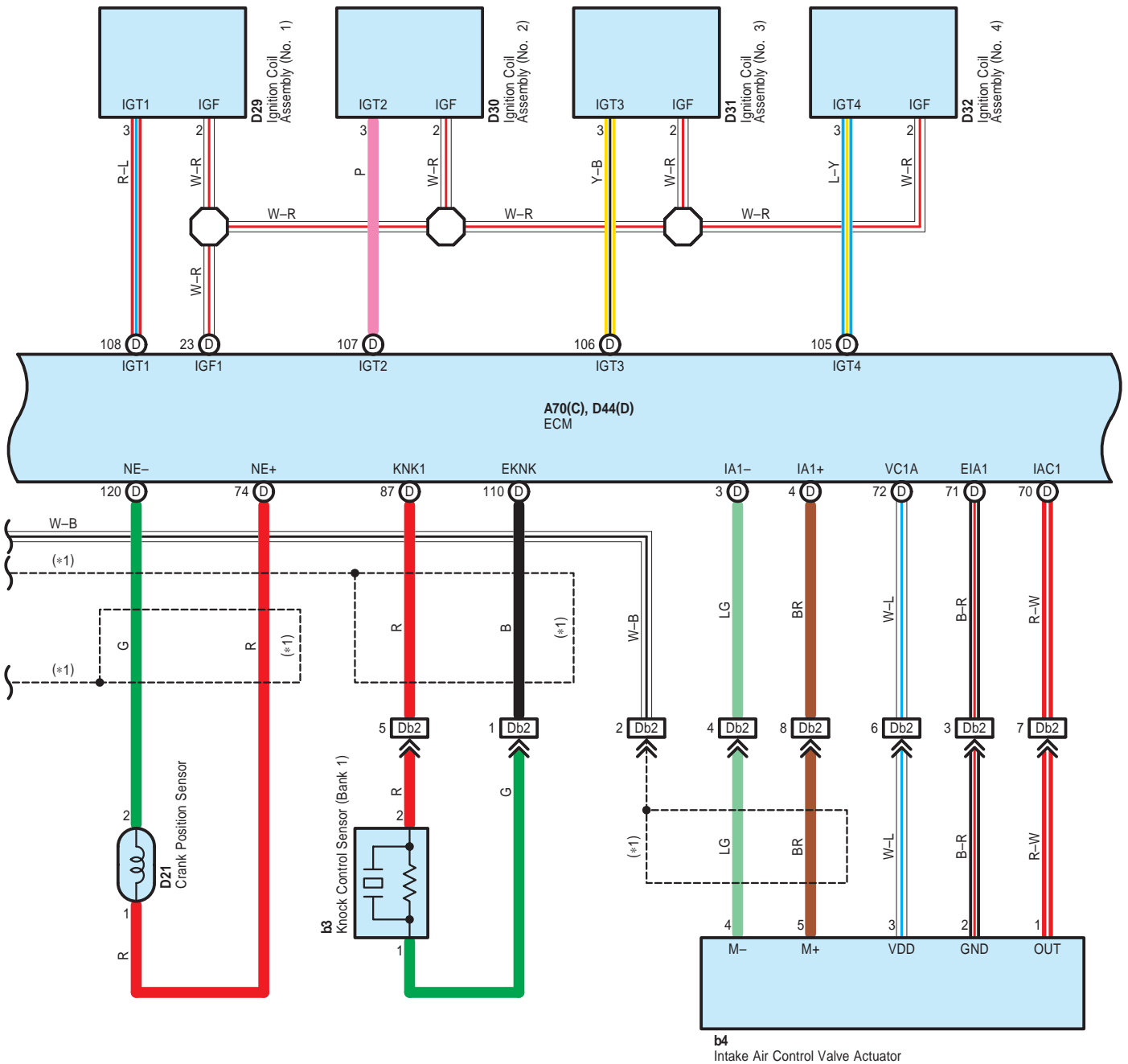



**A46**  
Accelerator Position Sensor (Accelerator Pedal Assembly)

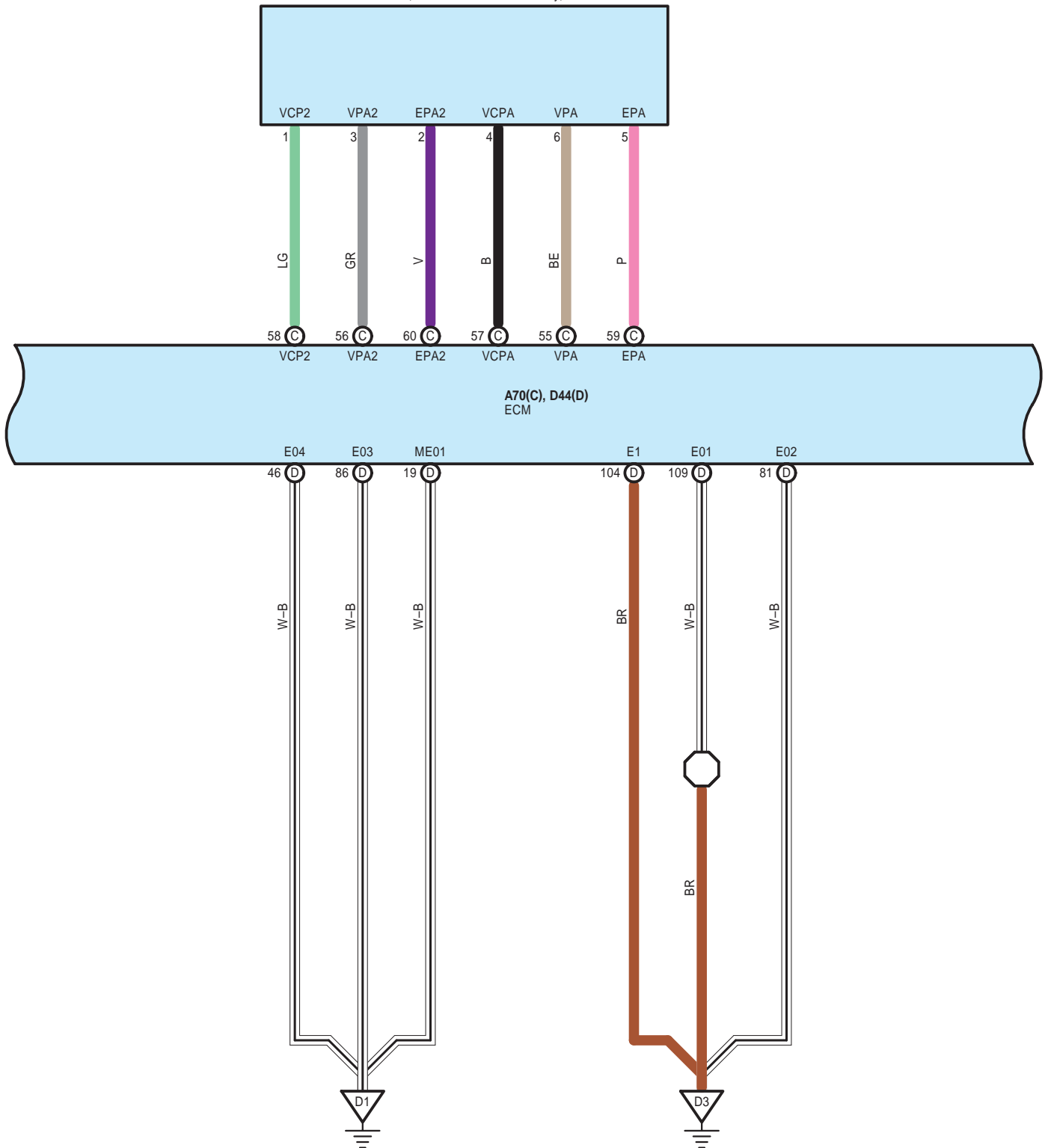

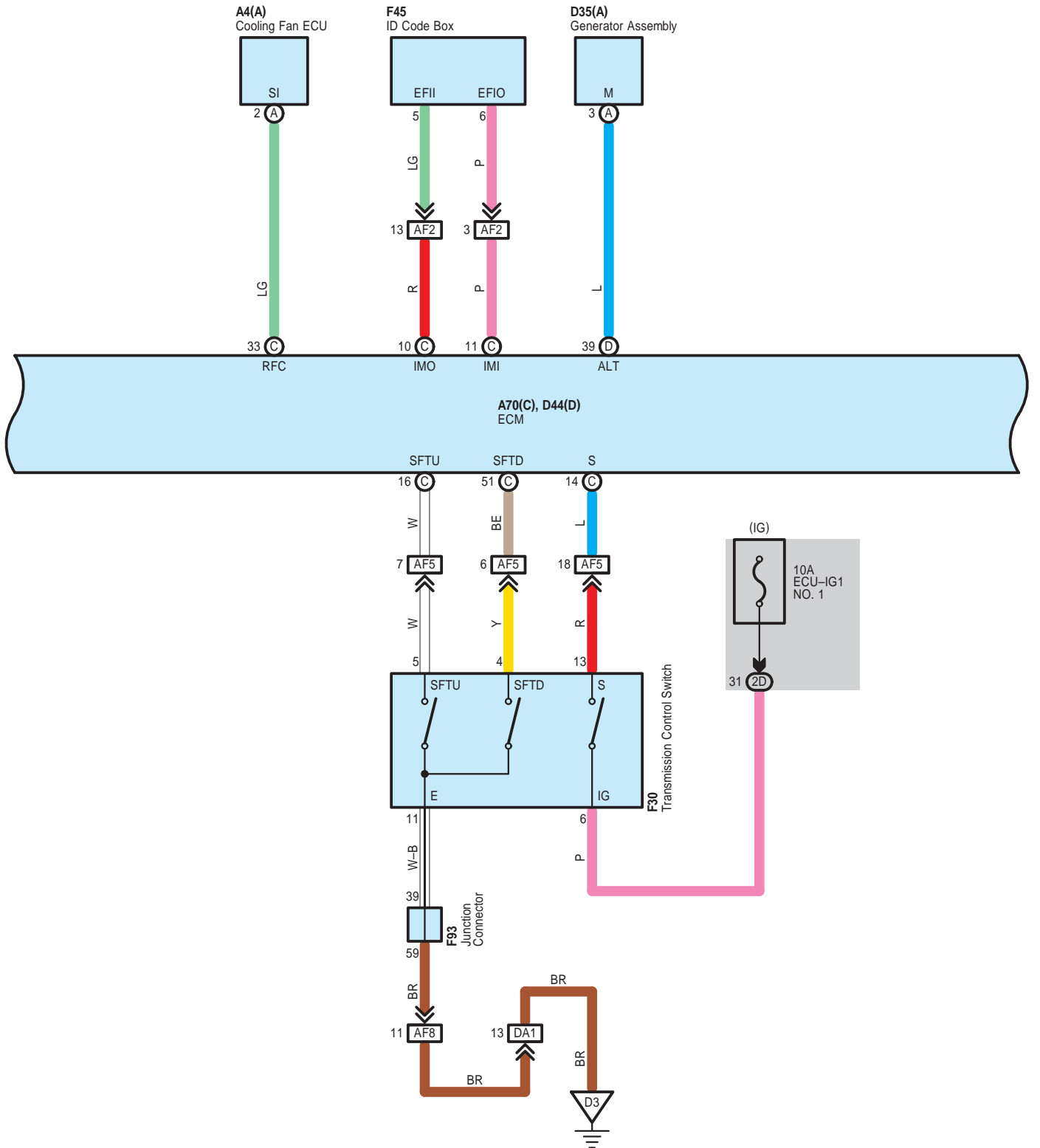



ECT and AT Indicator <1AR-FE> , Engine Control <1AR-FE>

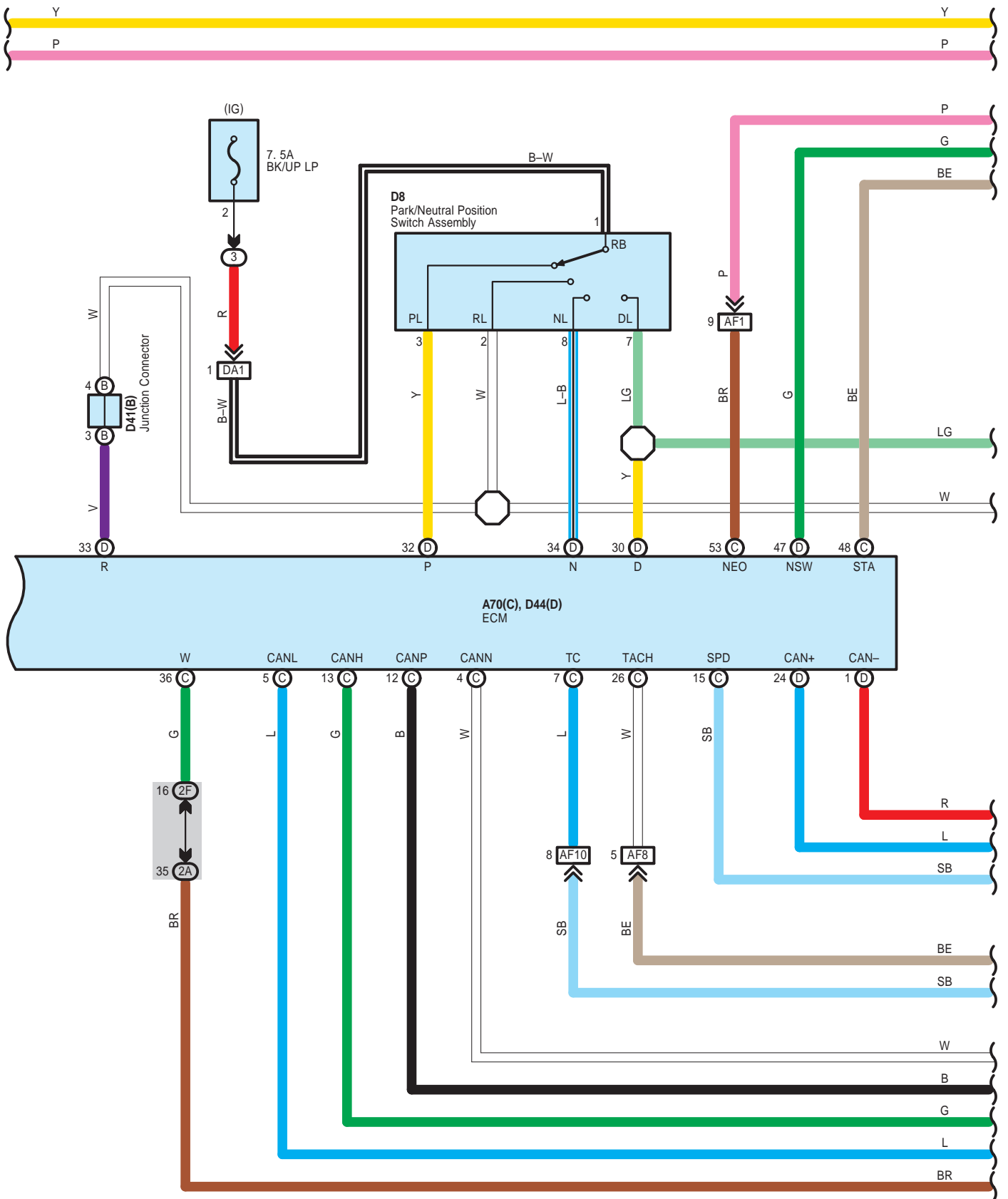

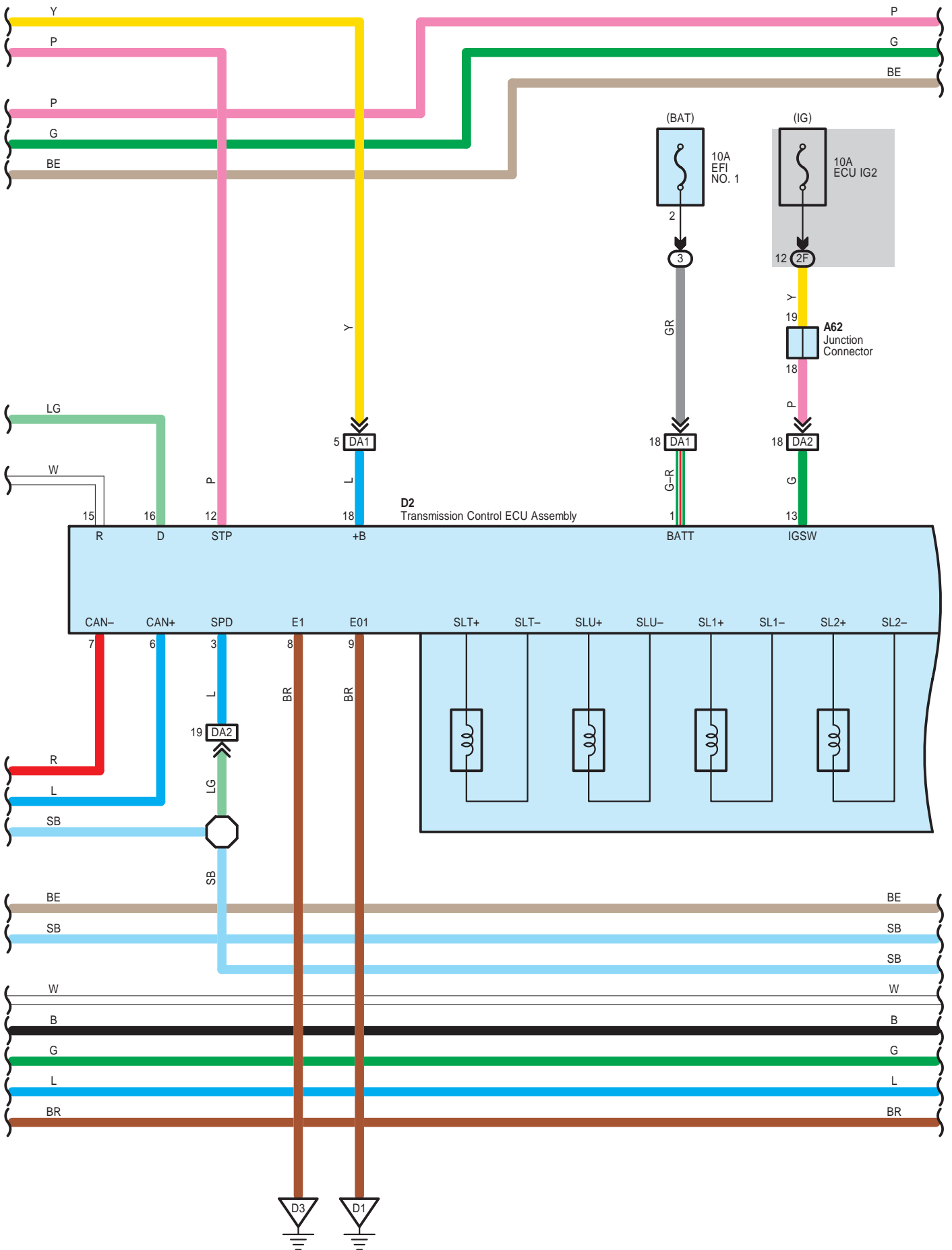

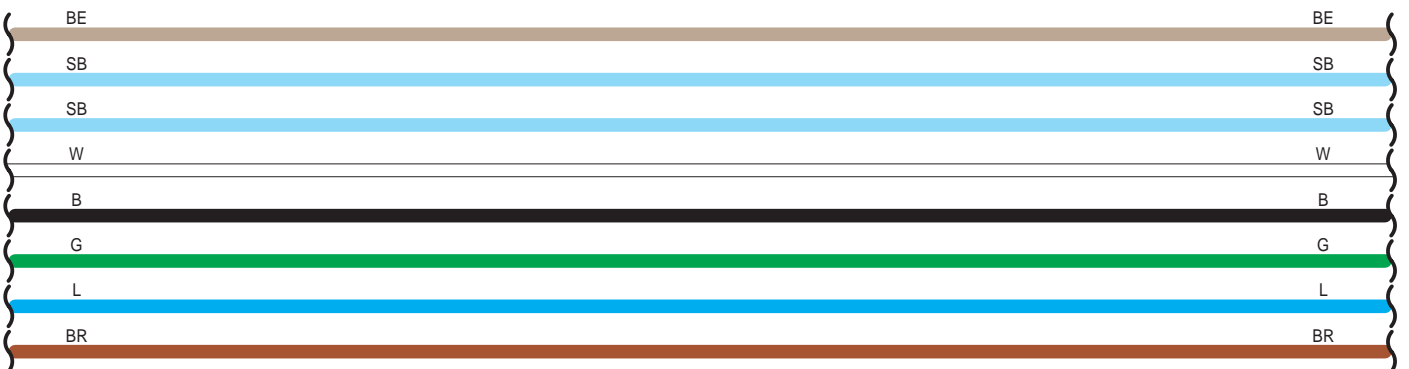
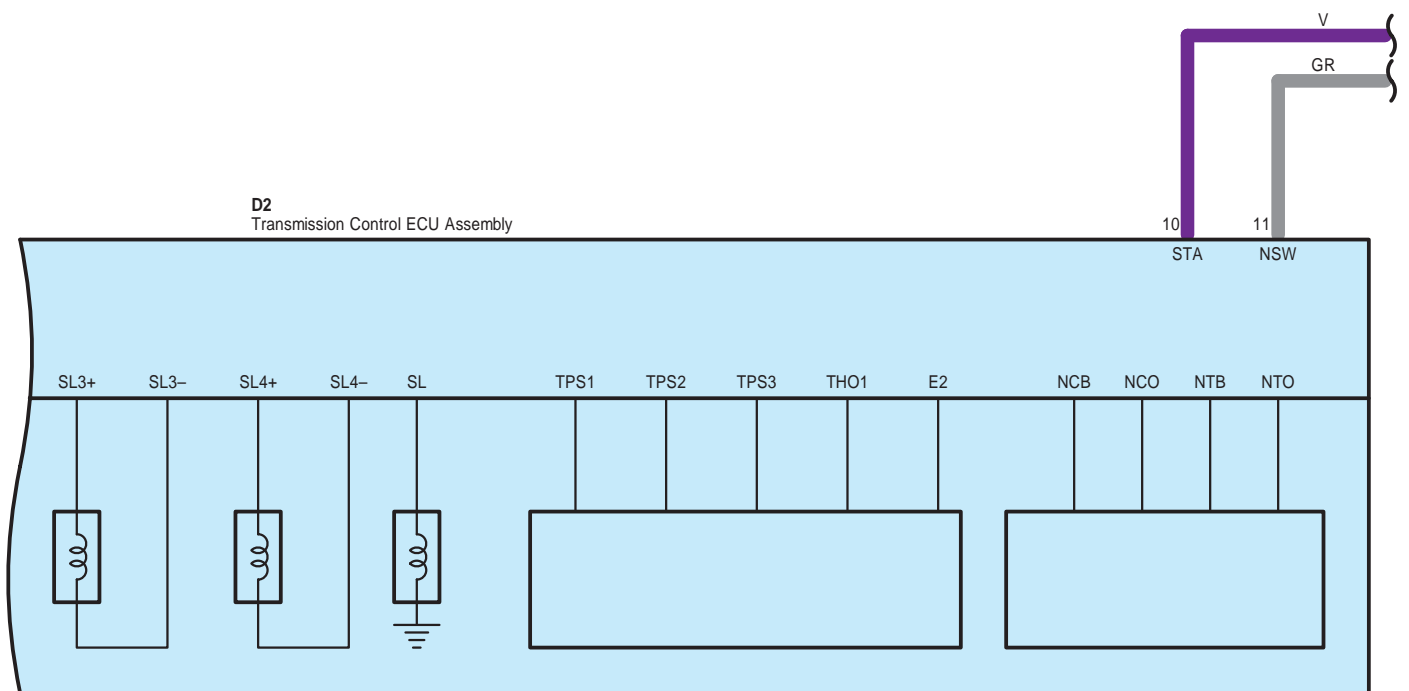

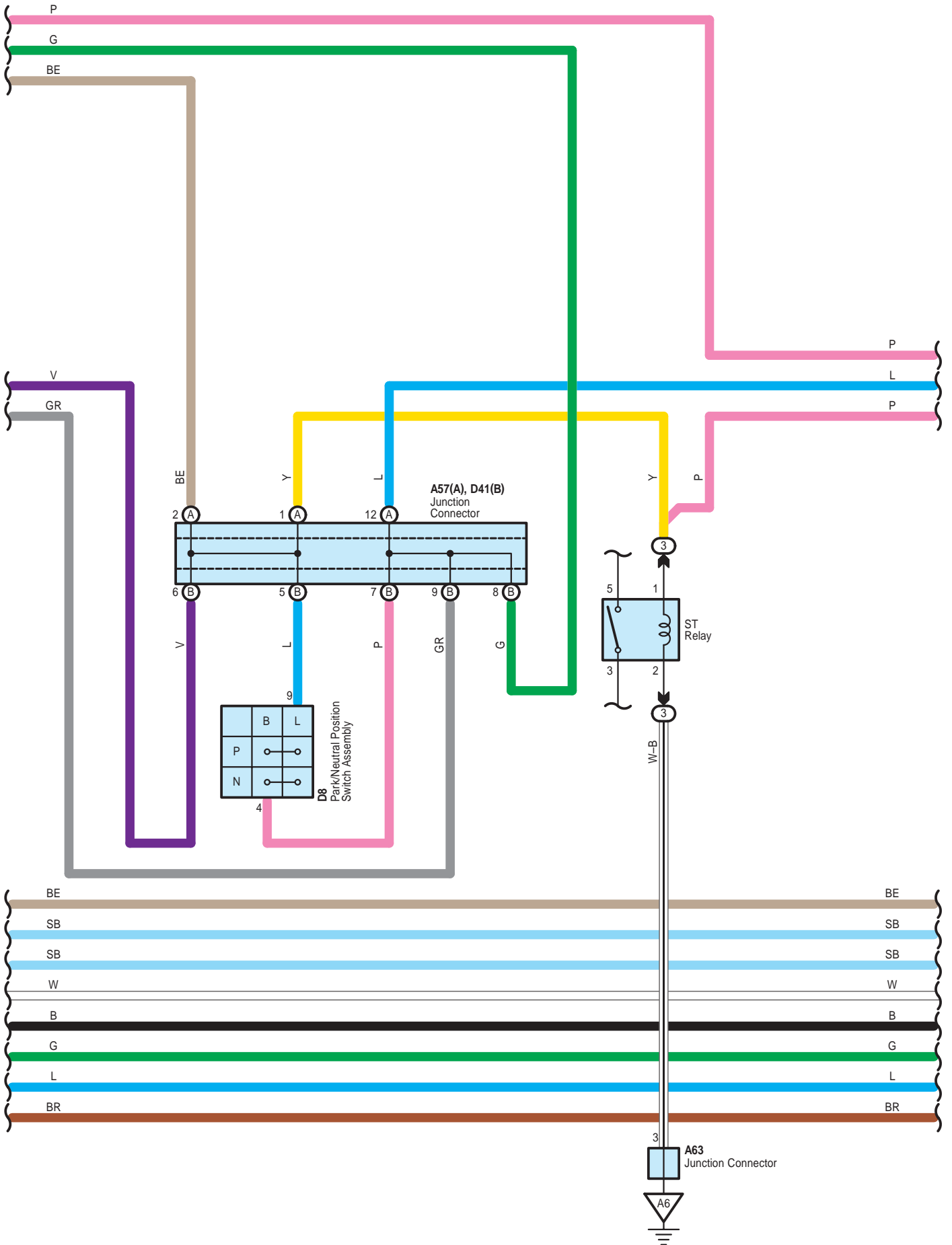

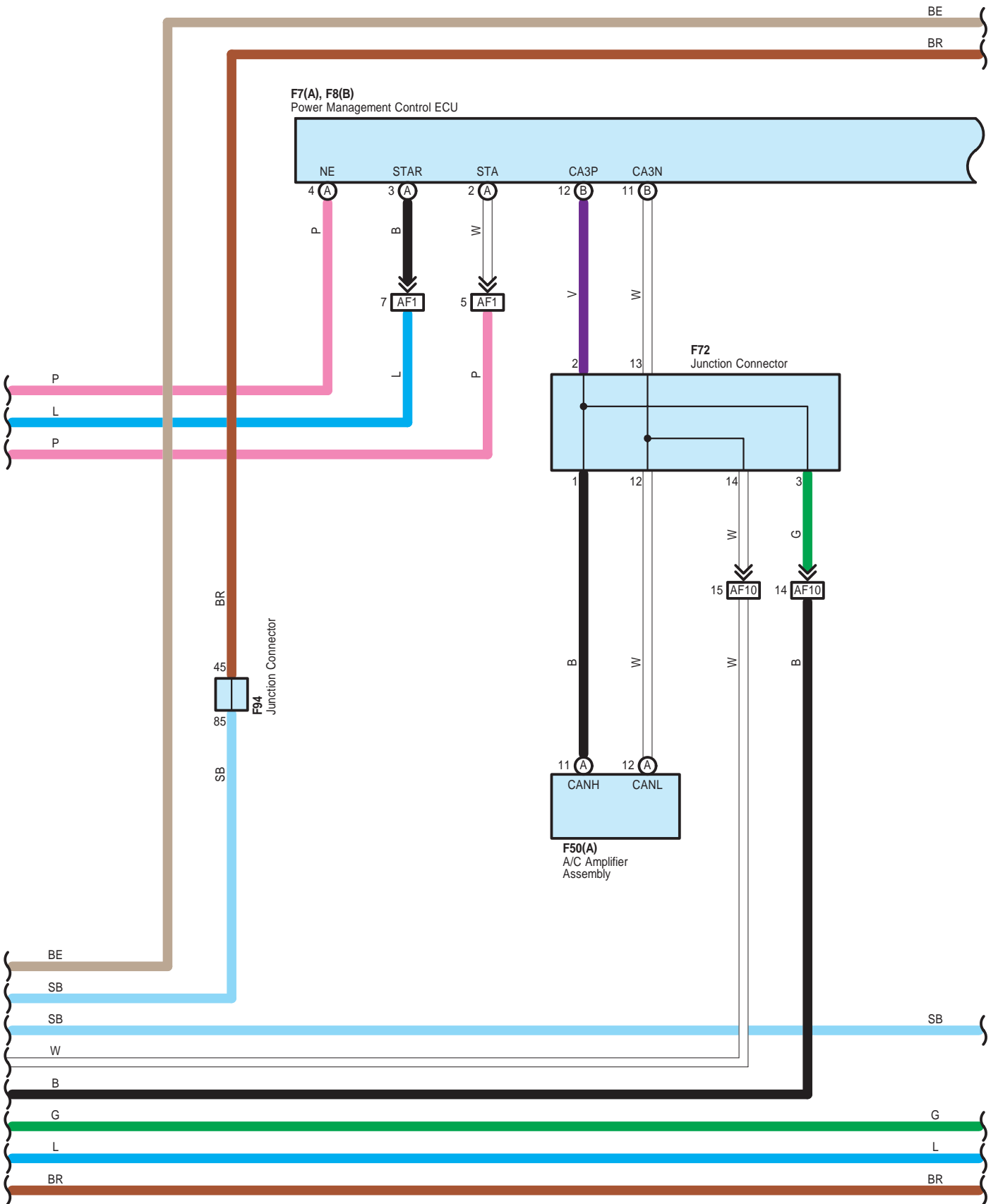

ECT and A/T Indicator <1AR-FE> , Engine Control <1AR-FE>

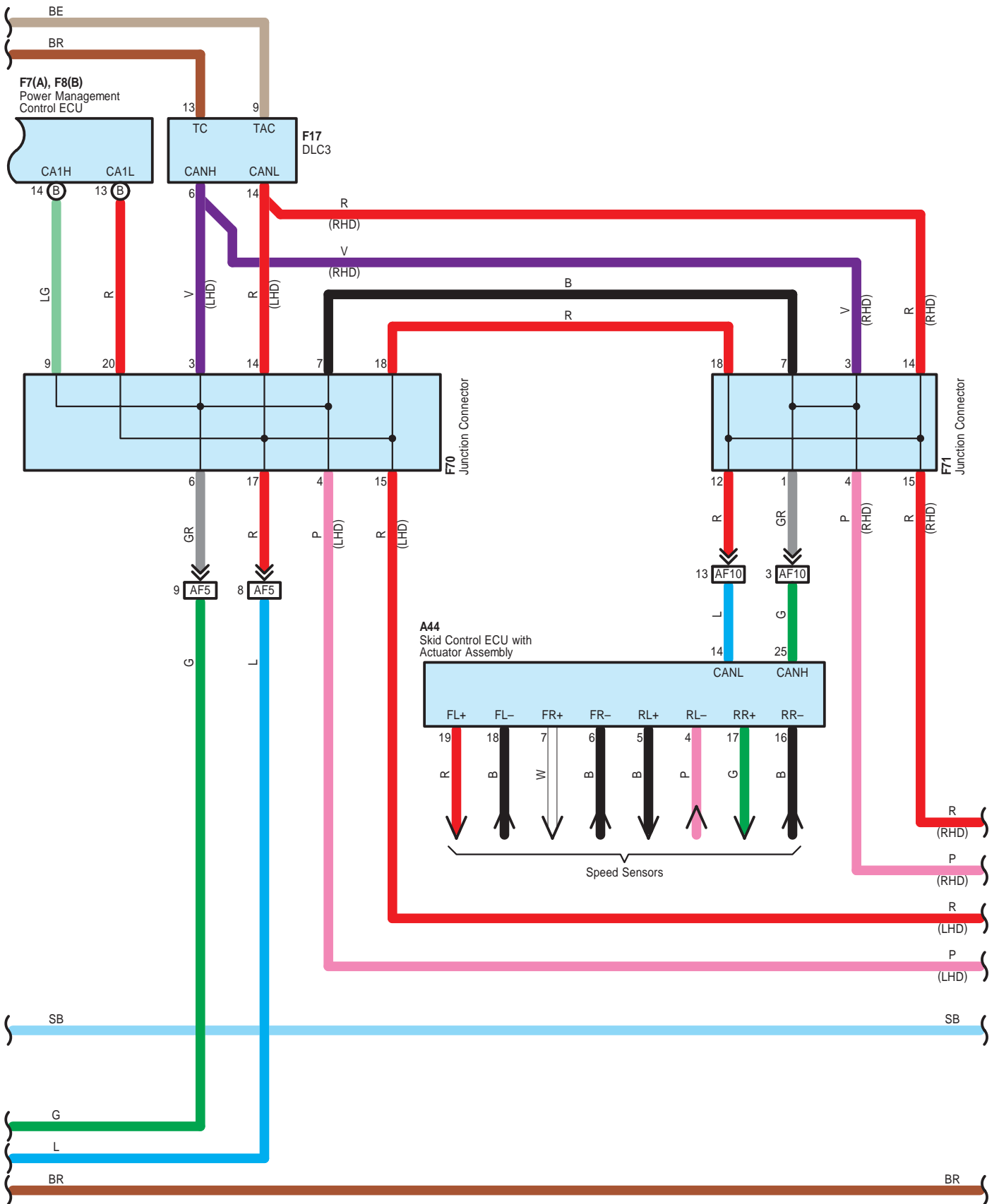

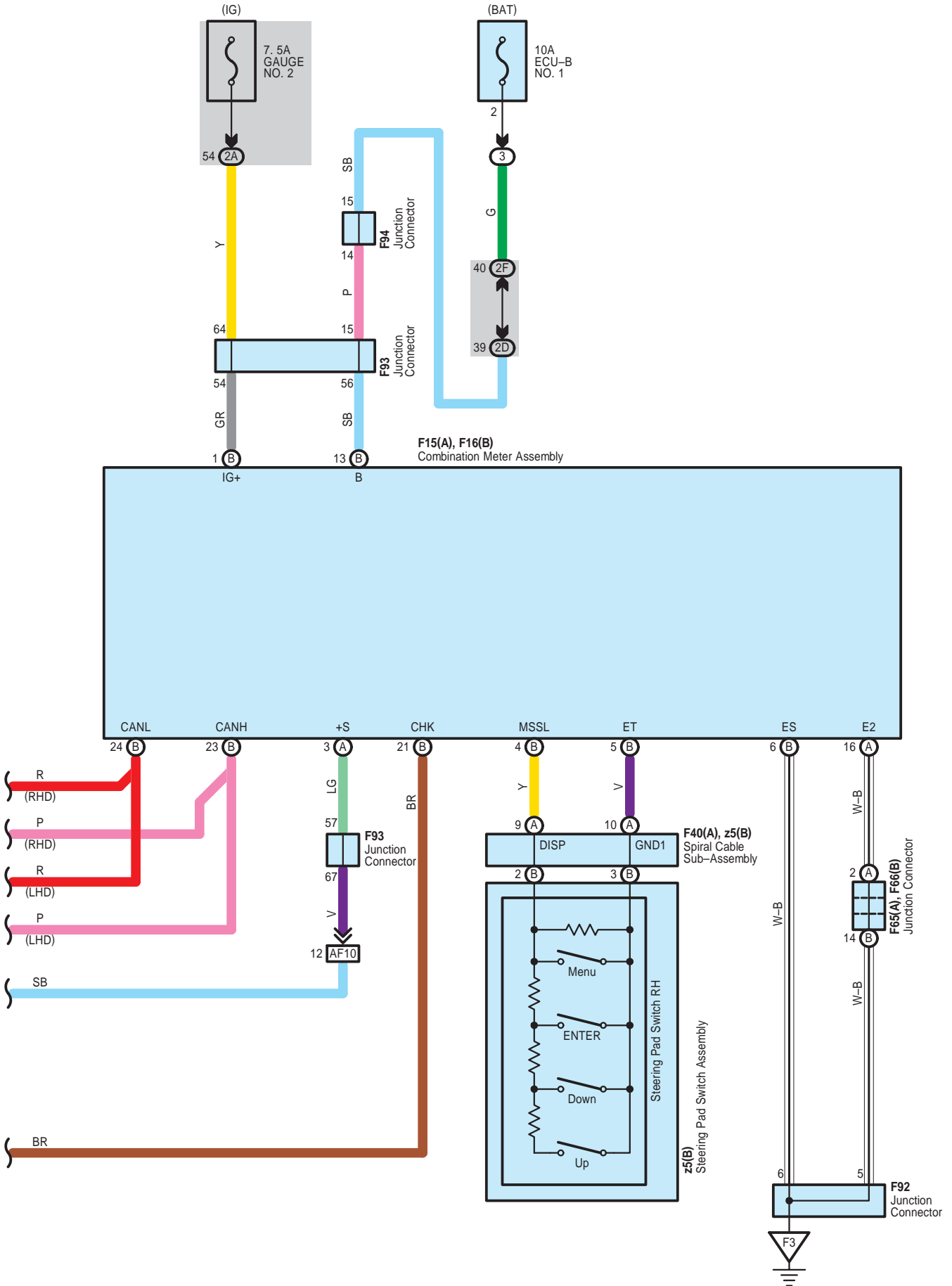

A 4  
Black

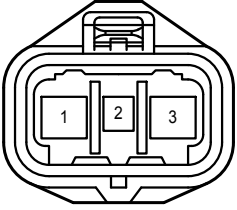

A 14  
Black

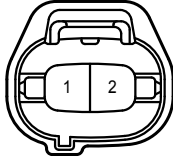

A 44  
Black

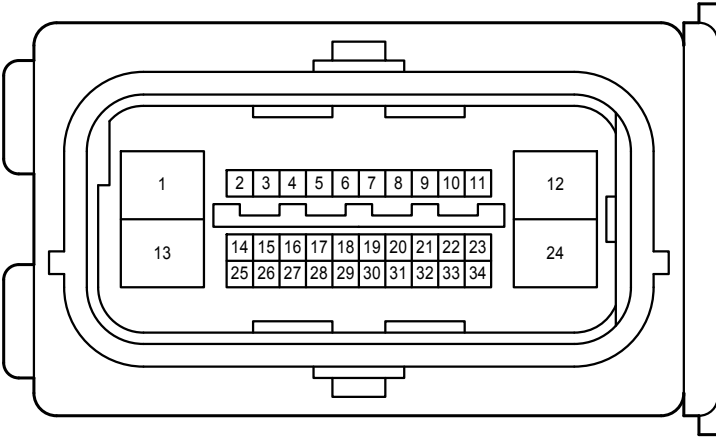

A 46  
Black

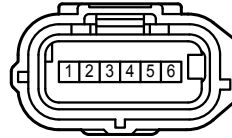

A 47  
Green

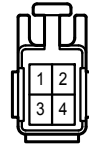

A 57  
Black

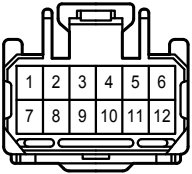

A 59  
Black

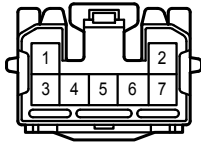

A 60  
White

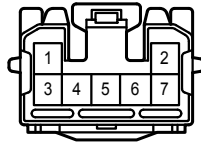

A 61  
Black

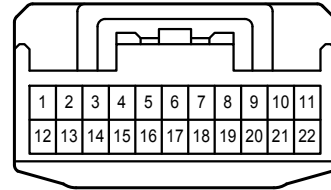

A 62  
Black

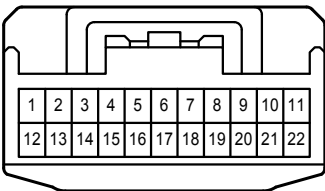

A 63  
White

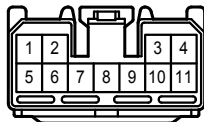



A 70  
Black

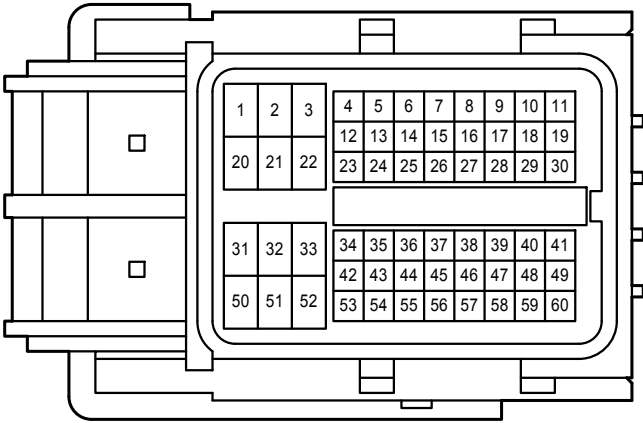

D 2  
Gray

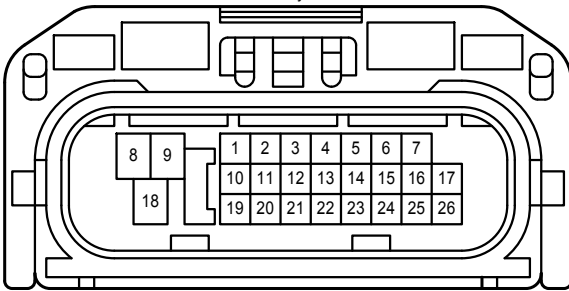

D 3  
Black

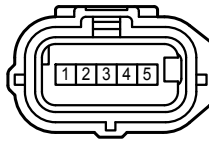

D 6  
Black

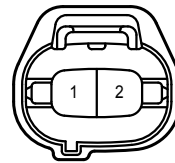

D 8  
Gray

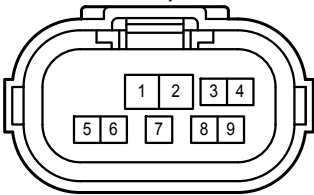

D 11  
Gray



D 20  
Dark Gray



D 21  
Black

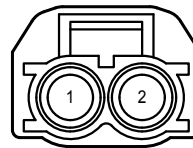

D 28  
Black

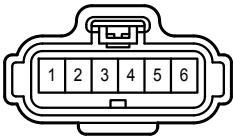

D 29  
Black

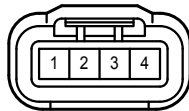

D 30  
Black

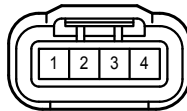

D 31  
Black

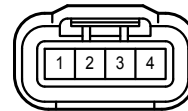

D 32  
Black

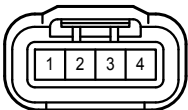

D 35  
Black



D 41  
Black

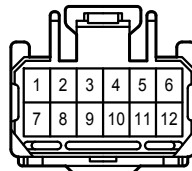

D 44  
Black

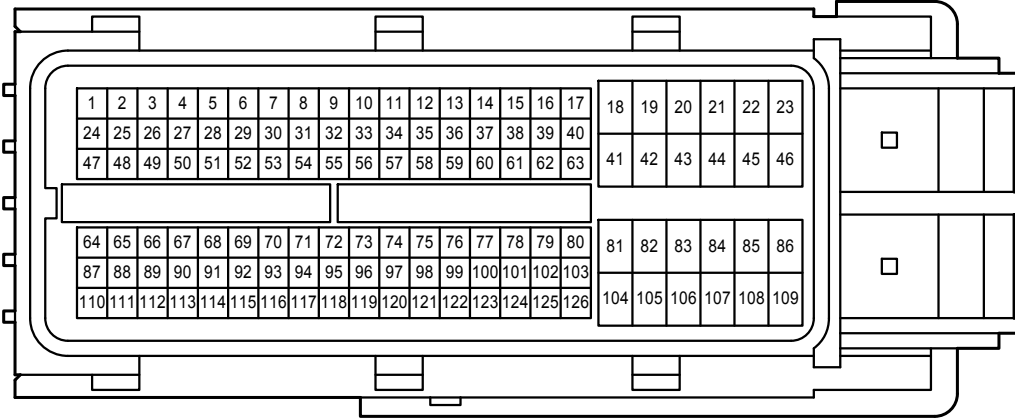

D 45  
Blue

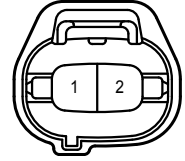

D 46  
Black

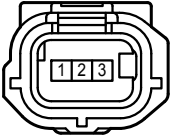

D 47  
Gray

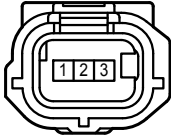

D 48  
Black



D 49  
Gray



D 50  
Black

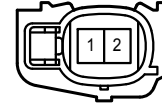

D 51  
Gray

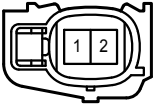

D 52  
Black

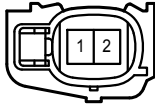

D 53  
Gray

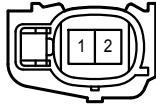

F 7  
Gray

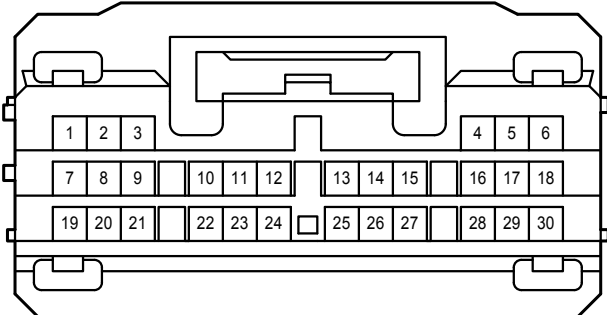

F 8  
Black

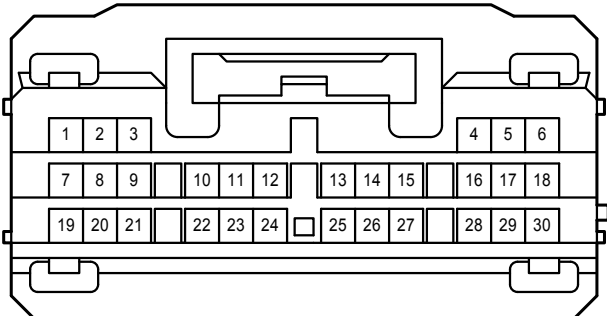

F 15  
Black

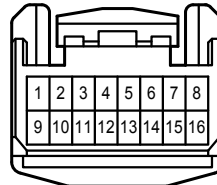

F 16  
Black

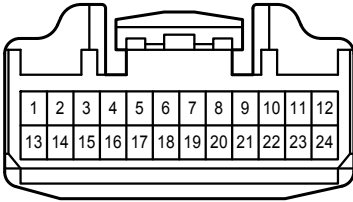

F 17  
White

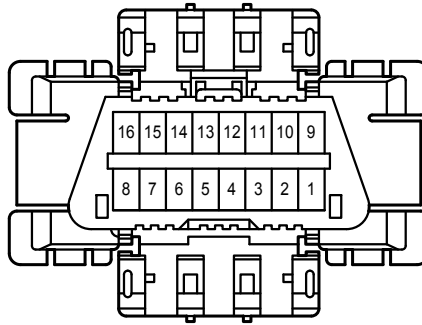

F 30  
White

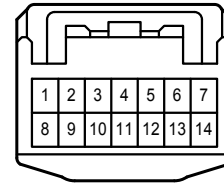

F 40  
Black



F 45  
White

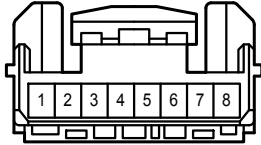

F 50  
White

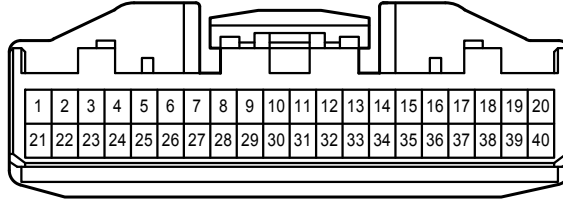

F 65  
White

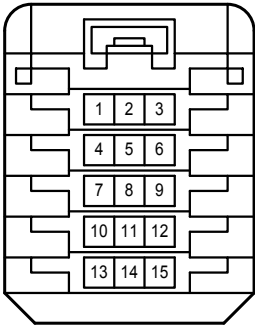

F 66  
White

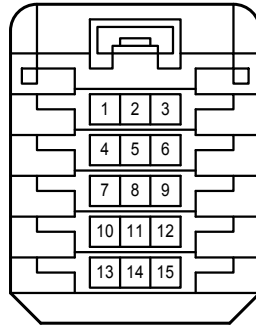

F 70  
Blue

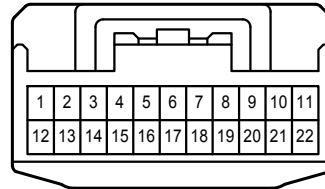

F 71  
Blue

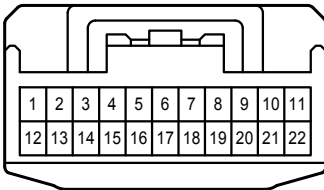

F 72  
White

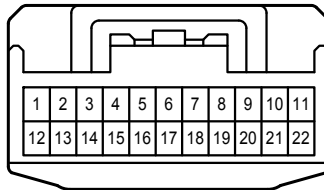

F 92  
White

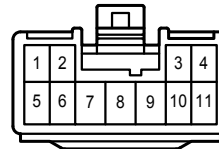

F 93  
White

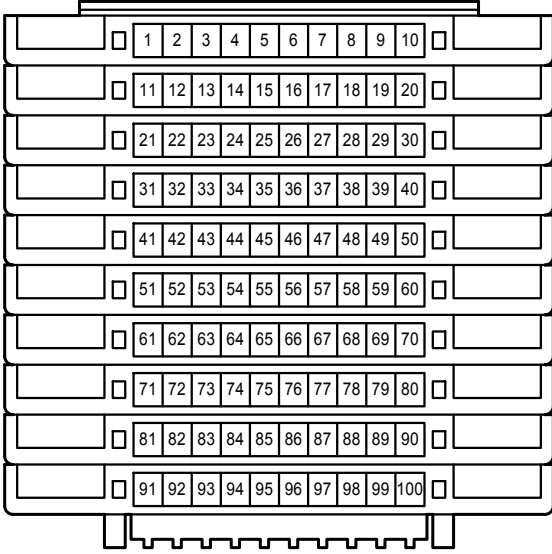

F 94  
White

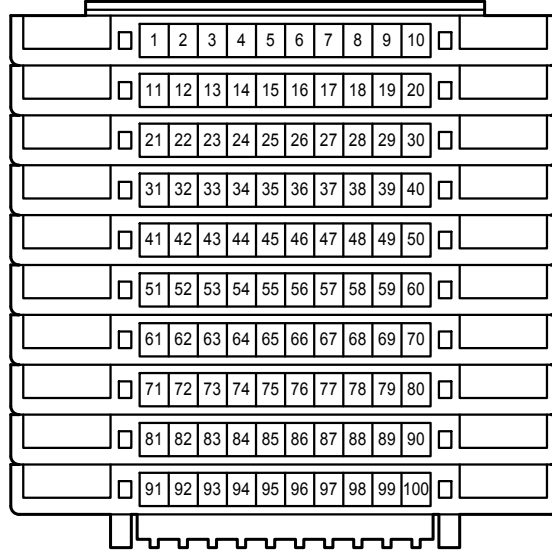

P 11  
White



P 38  
Black

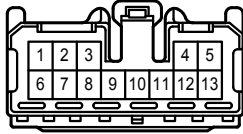

S 1  
Gray



b 3  
Black

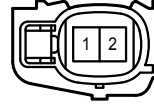

b 4  
Black



z 5  
White

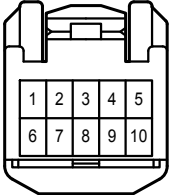

2A  
White

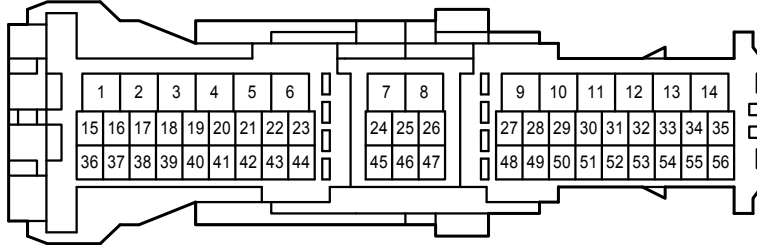

2D  
White

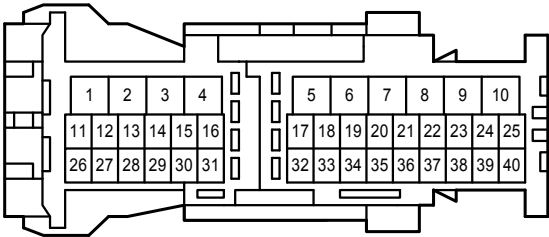

2F  
White

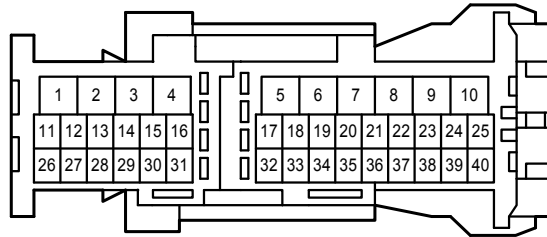

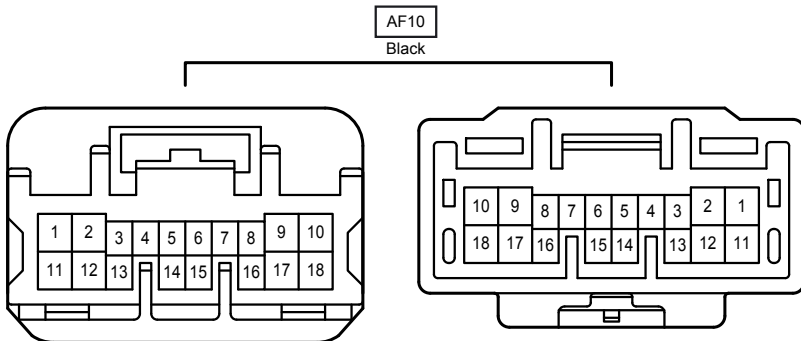
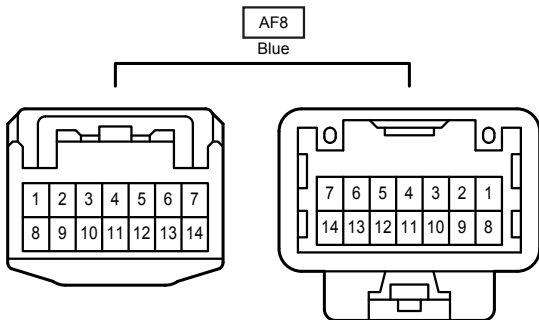
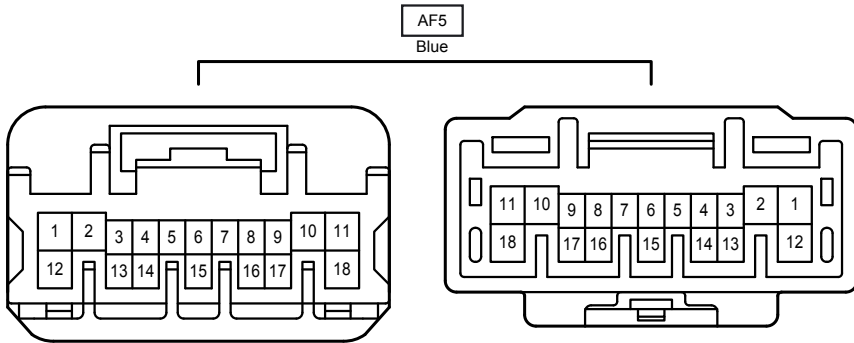
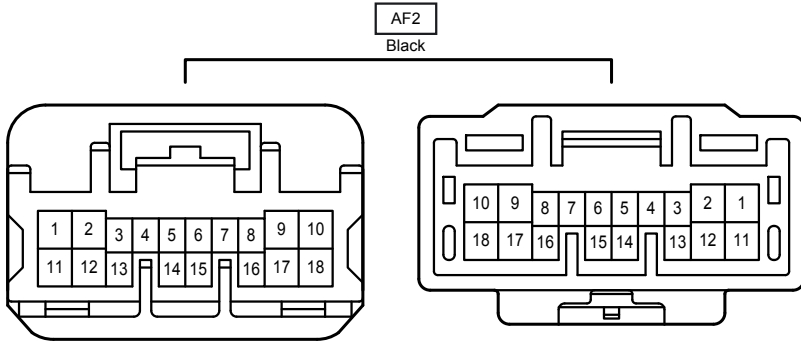
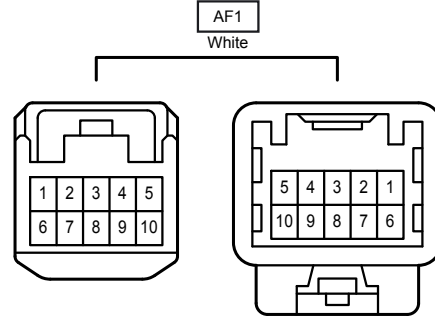
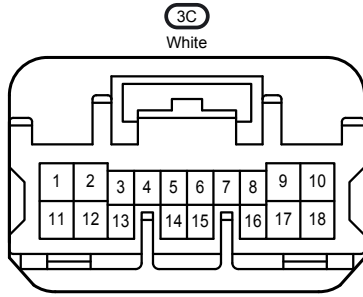
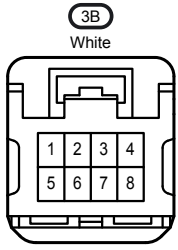

AP2  
White

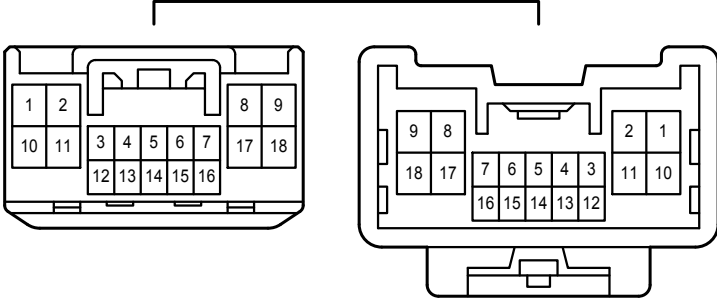

DA1  
White

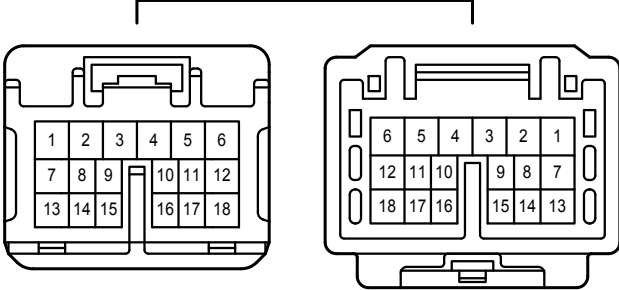

DA2  
White

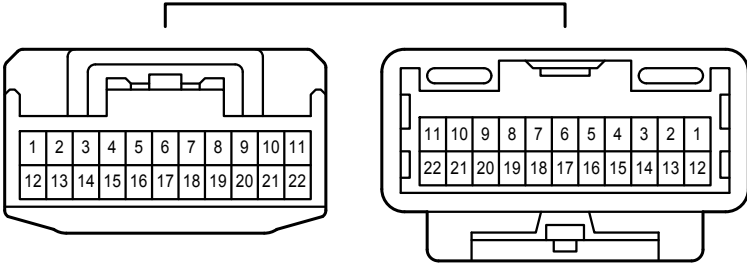

Db2  
Black      Gray

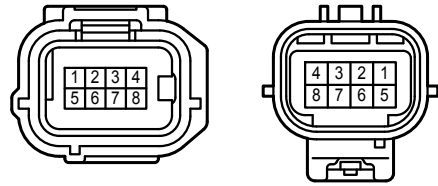

FS1  
Gray

