

Back Door Opener (w/o Power Back Door), Immobiliser System, Smart Access System with Push-Button Start, Starting, Steering Lock, Wireless Door Lock Control

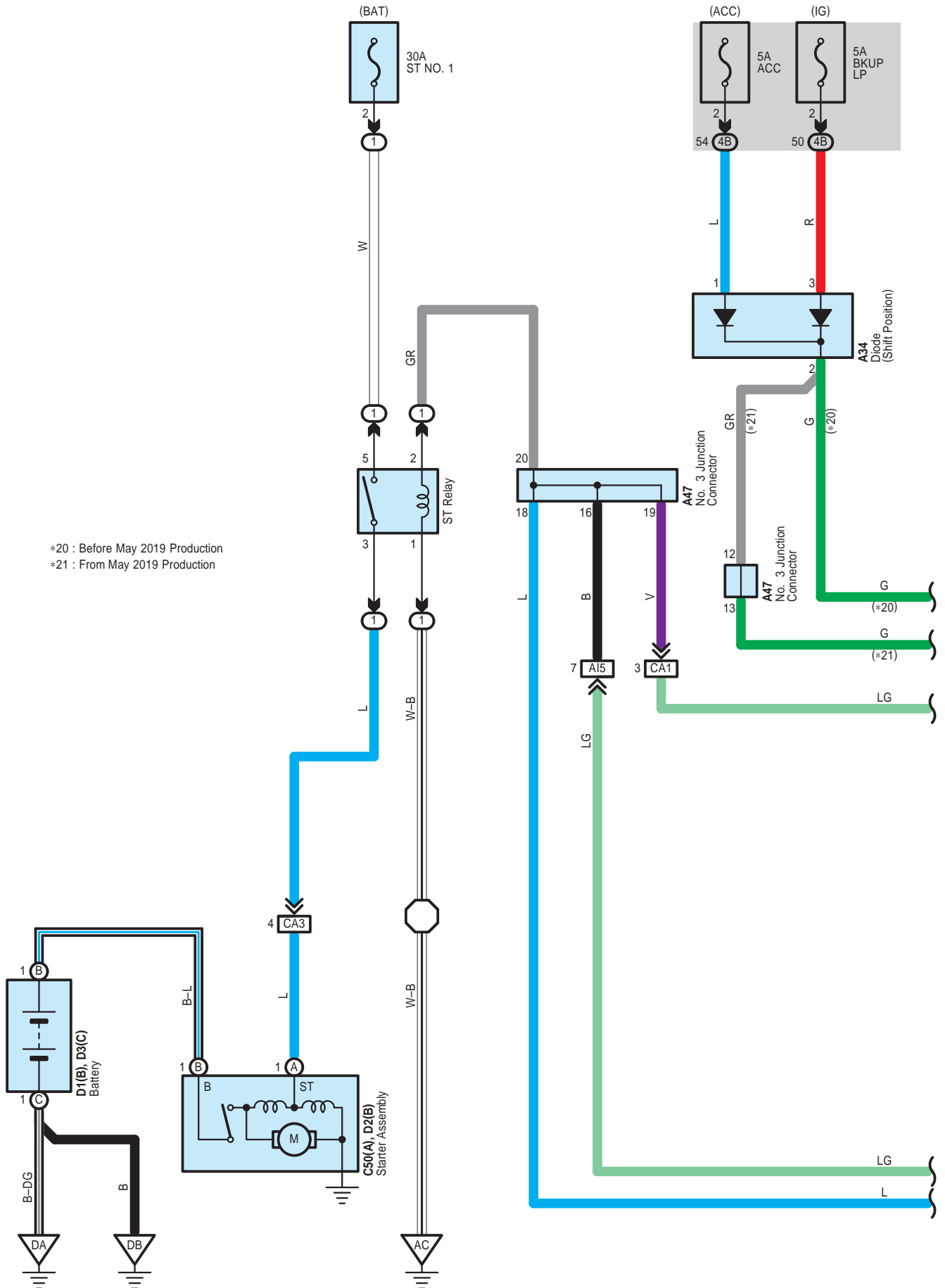

*20 : Before May 2019 Production
 *21 : From May 2019 Production

Back Door Opener (w/o Power Back Door), Immobiliser System, Smart Access System with Push-Button Start, Starting, Steering Lock, Wireless Door Lock Control

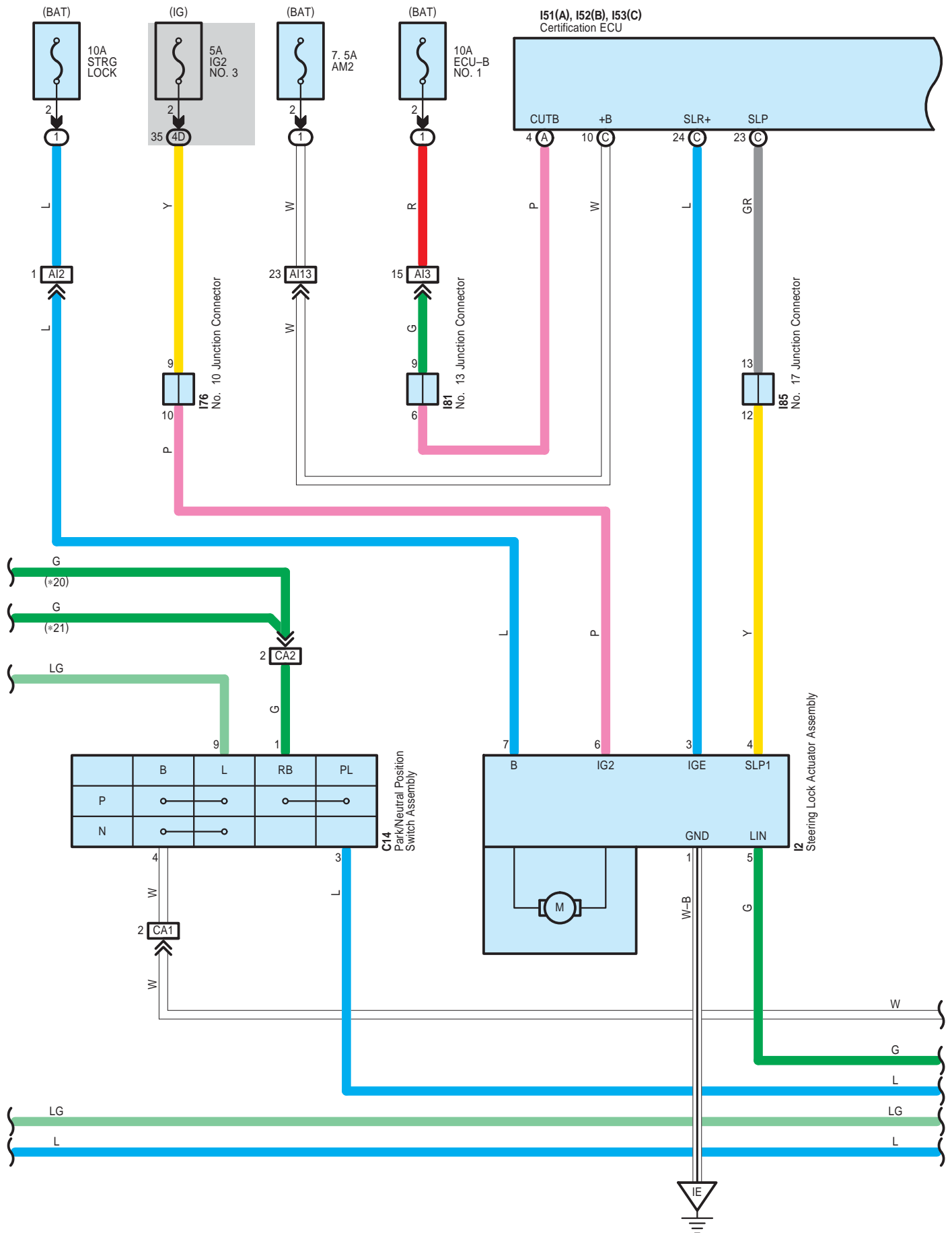

Back Door Opener (w/o Power Back Door), Immobiliser System, Smart Access System with Push-Button Start, Starting, Steering Lock, Wireless Door Lock Control

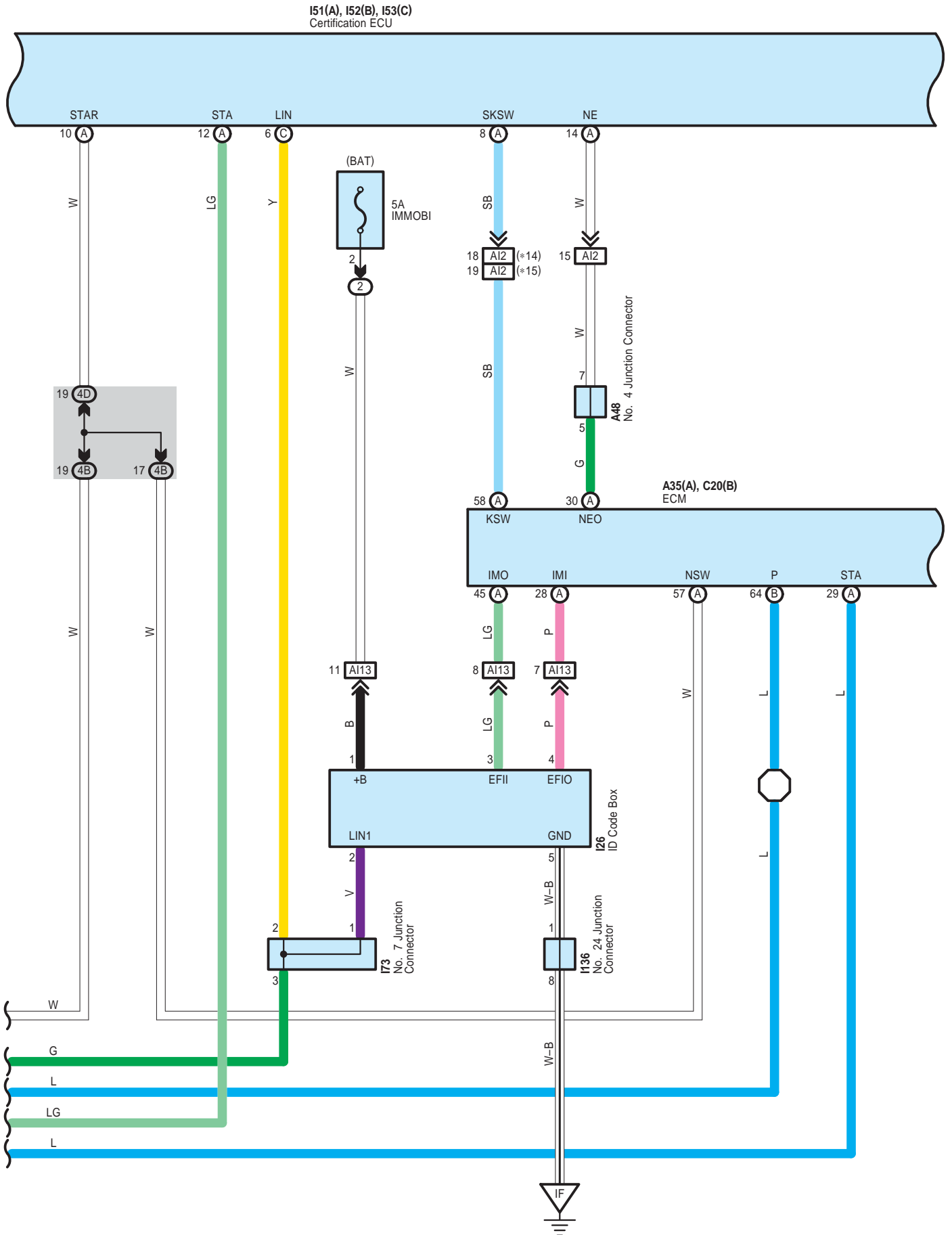

Back Door Opener (w/o Power Back Door), Immobiliser System, Smart Access System with Push-Button Start, Starting, Steering Lock, Wireless Door Lock Control

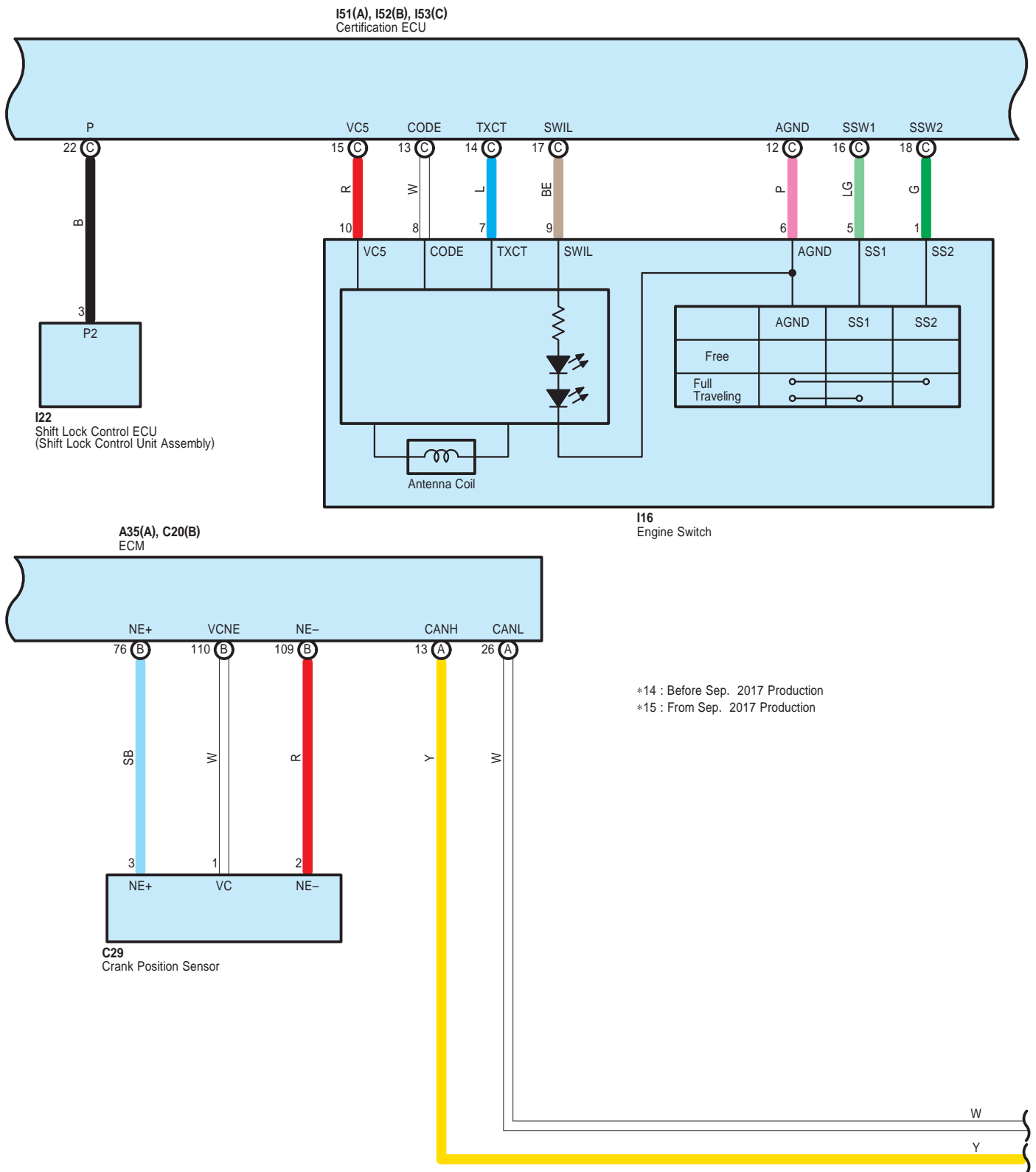

I51(A), I52(B), I53(C)
Certification ECU

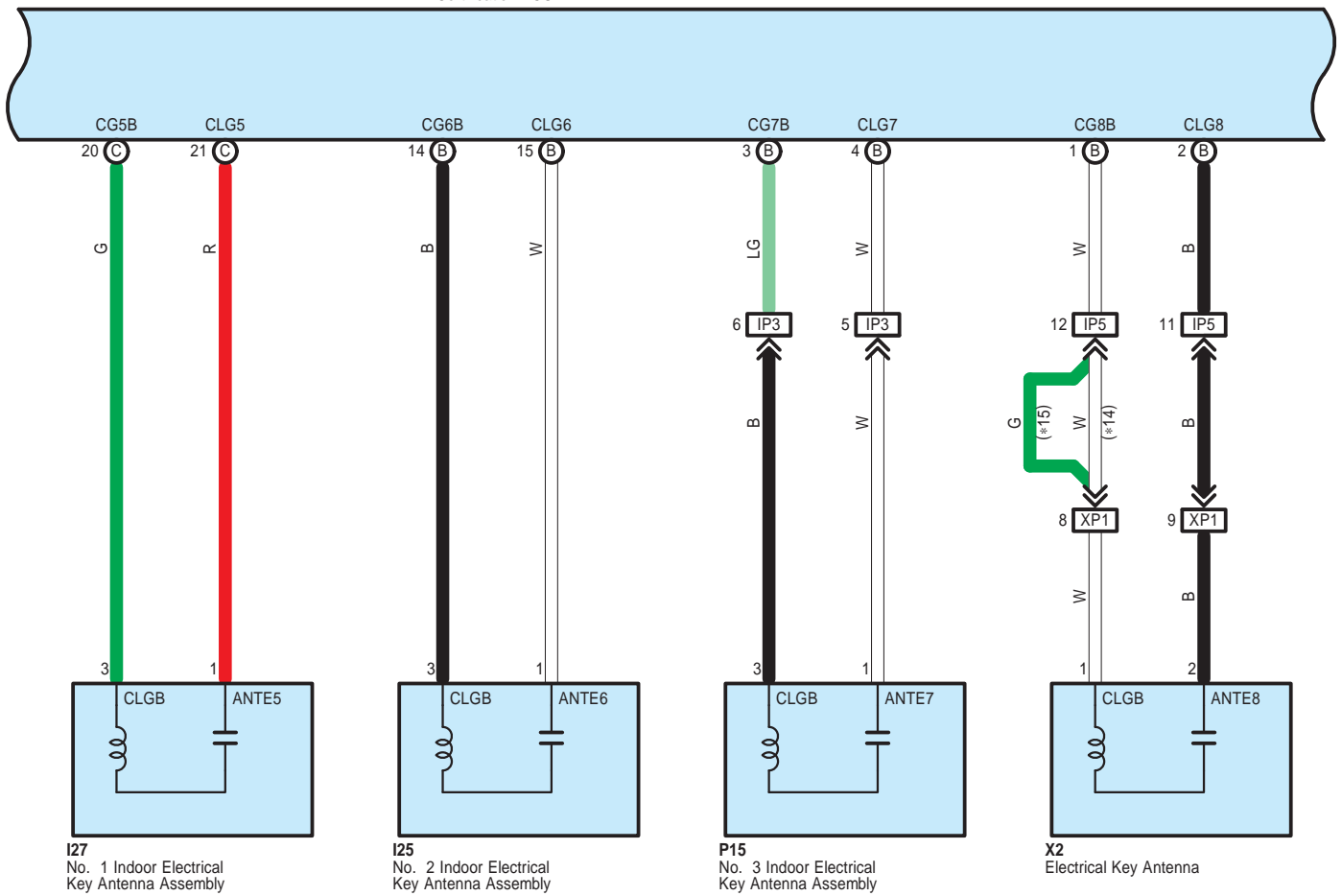

*14 : Before Sep. 2017 Production

*15 : From Sep. 2017 Production

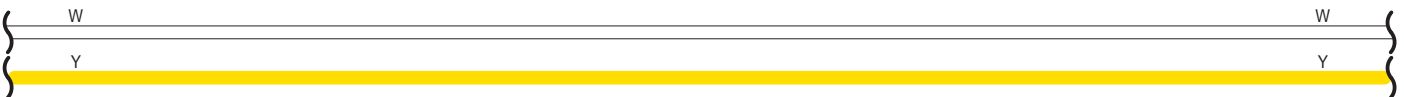

I51(A), I52(B), I53(C)
Certification ECU

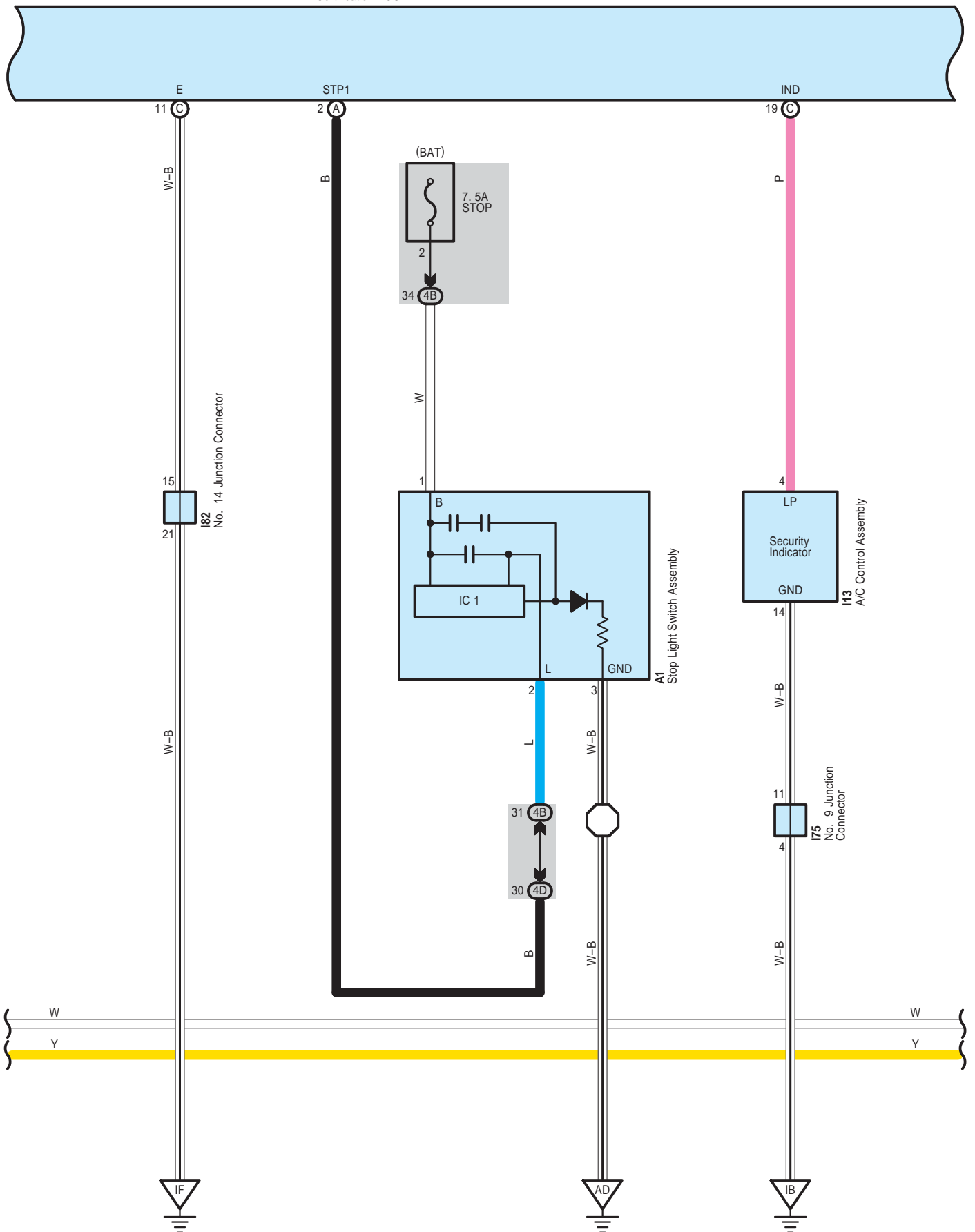

Back Door Opener (w/o Power Back Door), Immobiliser System, Smart Access System with Push-Button Start, Starting, Steering Lock, Wireless Door Lock Control

I51(A), I52(B), I53(C)
Certification ECU

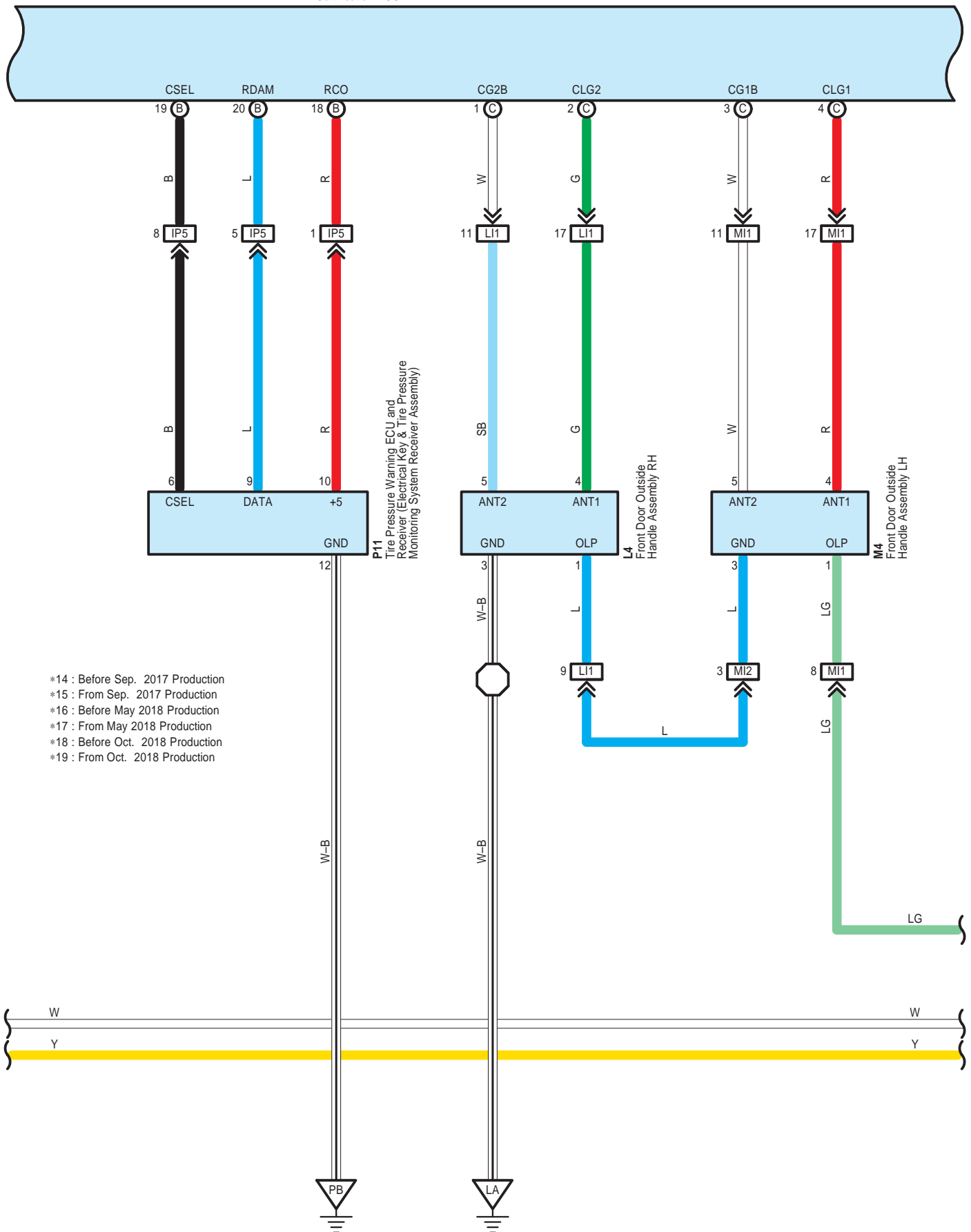

Back Door Opener (w/o Power Back Door), Immobiliser System, Smart Access System with Push-Button Start, Starting, Steering Lock, Wireless Door Lock Control

I51(A), I52(B), I53(C)
Certification ECU

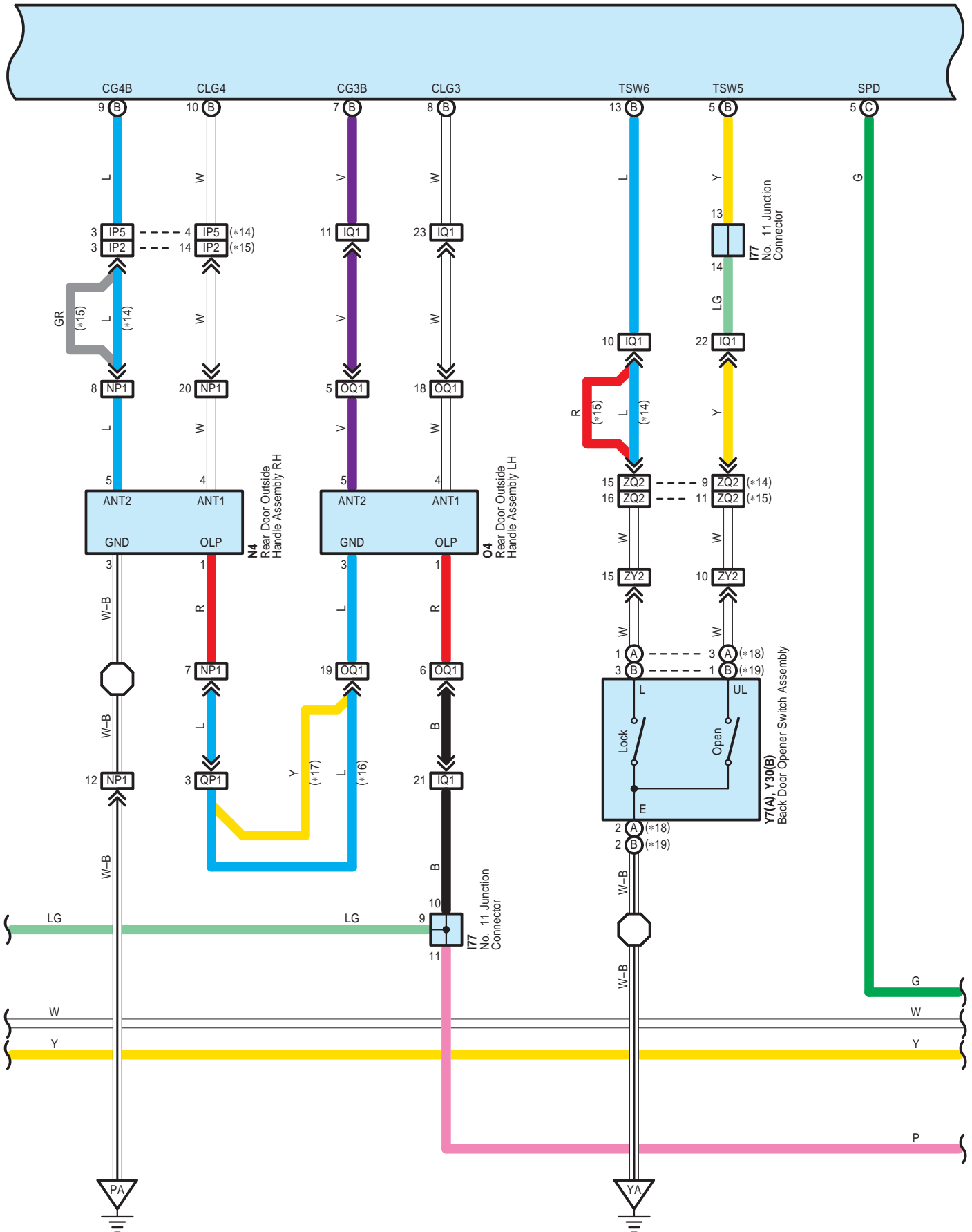

Back Door Opener (w/o Power Back Door), Immobiliser System, Smart Access System with Push-Button Start, Starting, Steering Lock, Wireless Door Lock Control

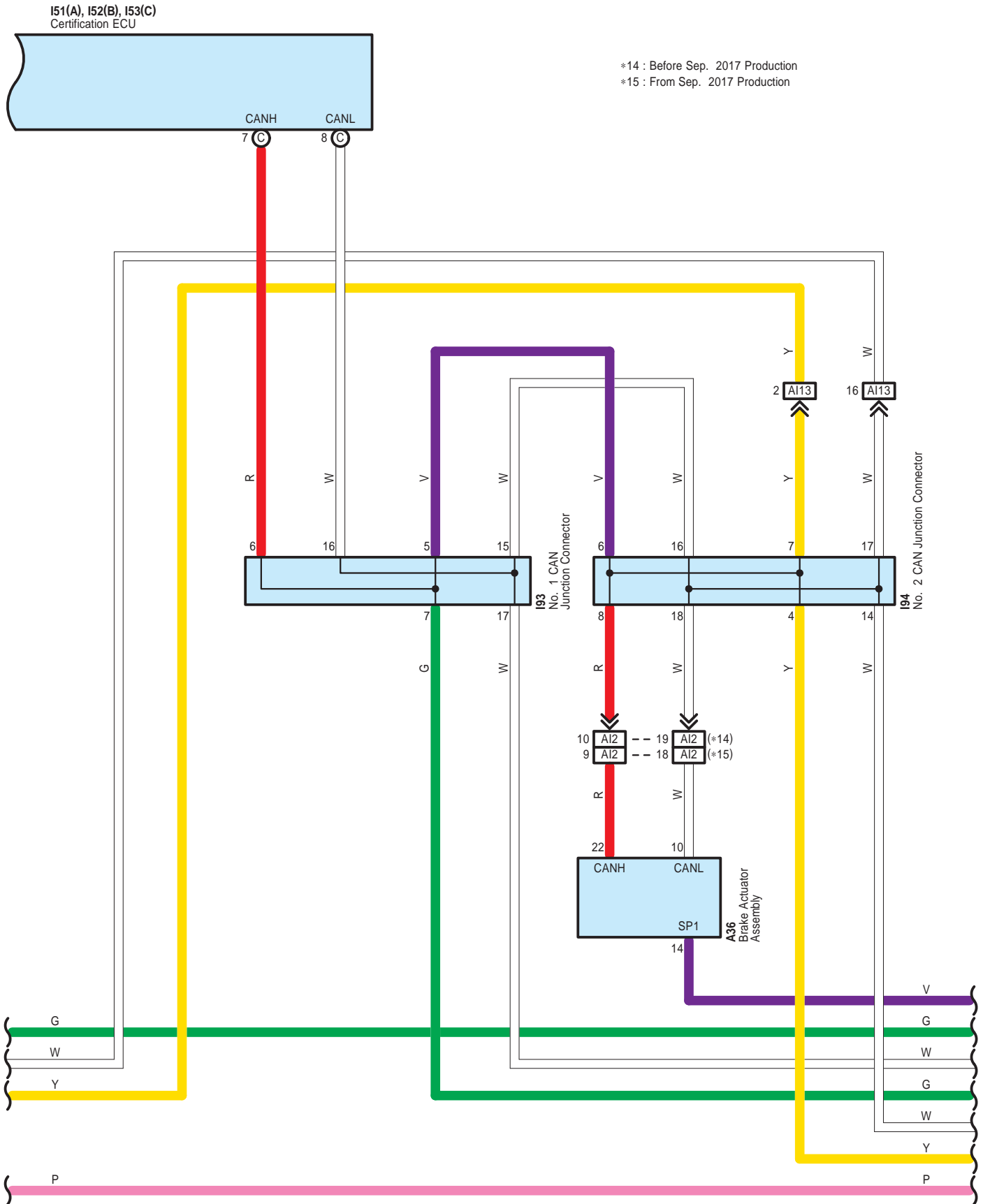

Back Door Opener (w/o Power Back Door), Immobiliser System, Smart Access System with Push-Button Start, Starting, Steering Lock, Wireless Door Lock Control

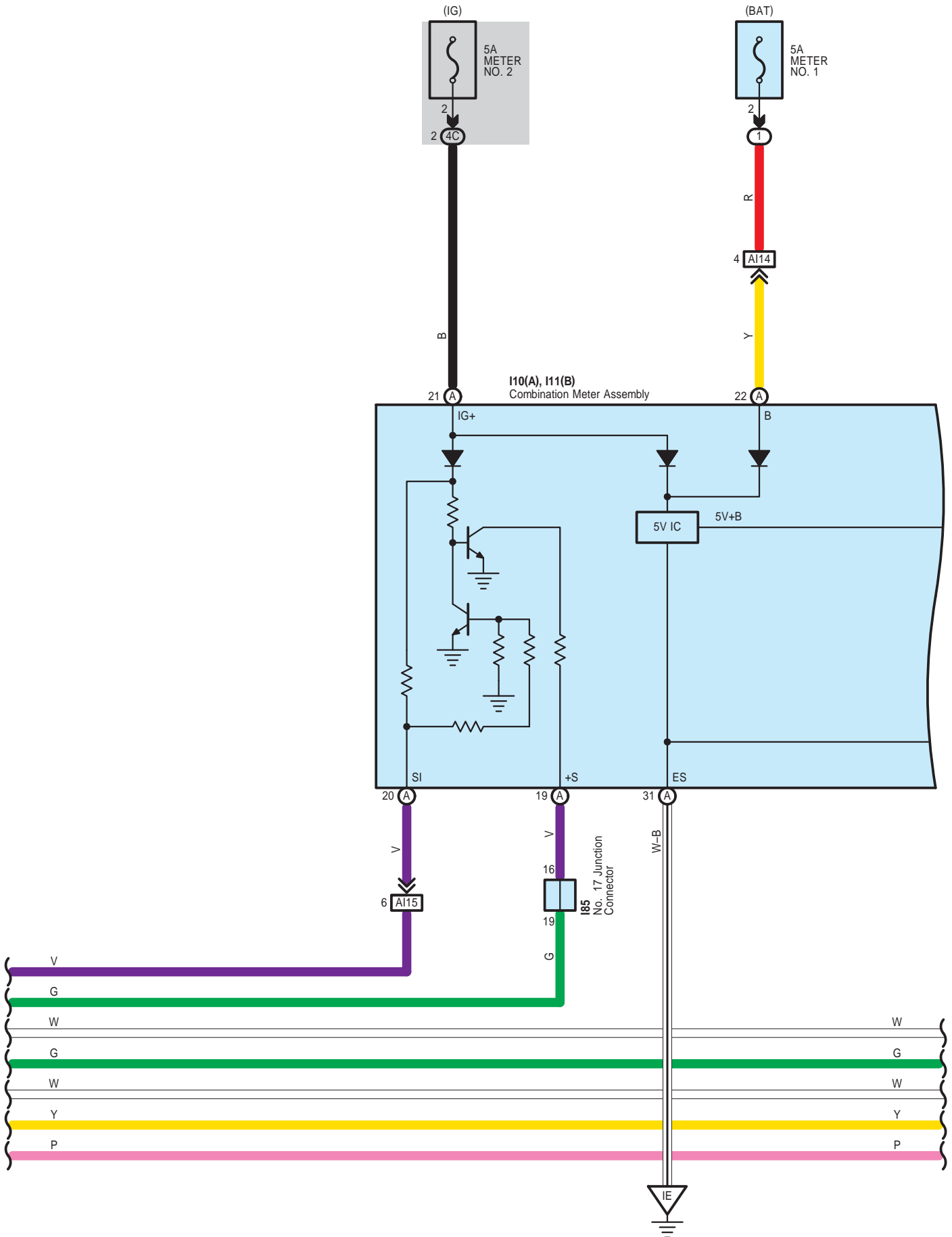

Back Door Opener (w/o Power Back Door), Immobiliser System, Smart Access System with Push-Button Start, Starting, Steering Lock, Wireless Door Lock Control

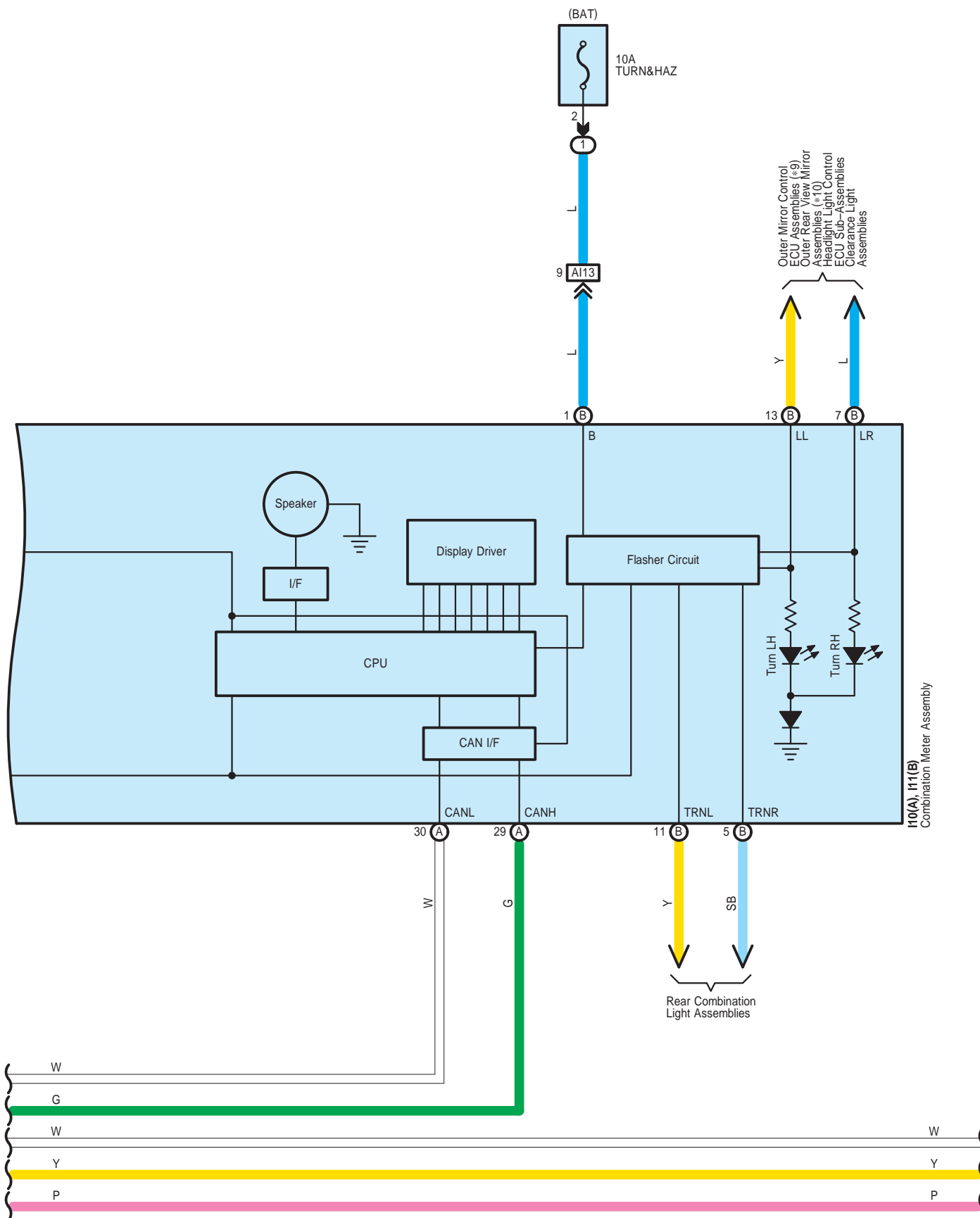

Back Door Opener (w/o Power Back Door), Immobiliser System, Smart Access System with Push-Button Start, Starting, Steering Lock, Wireless Door Lock Control

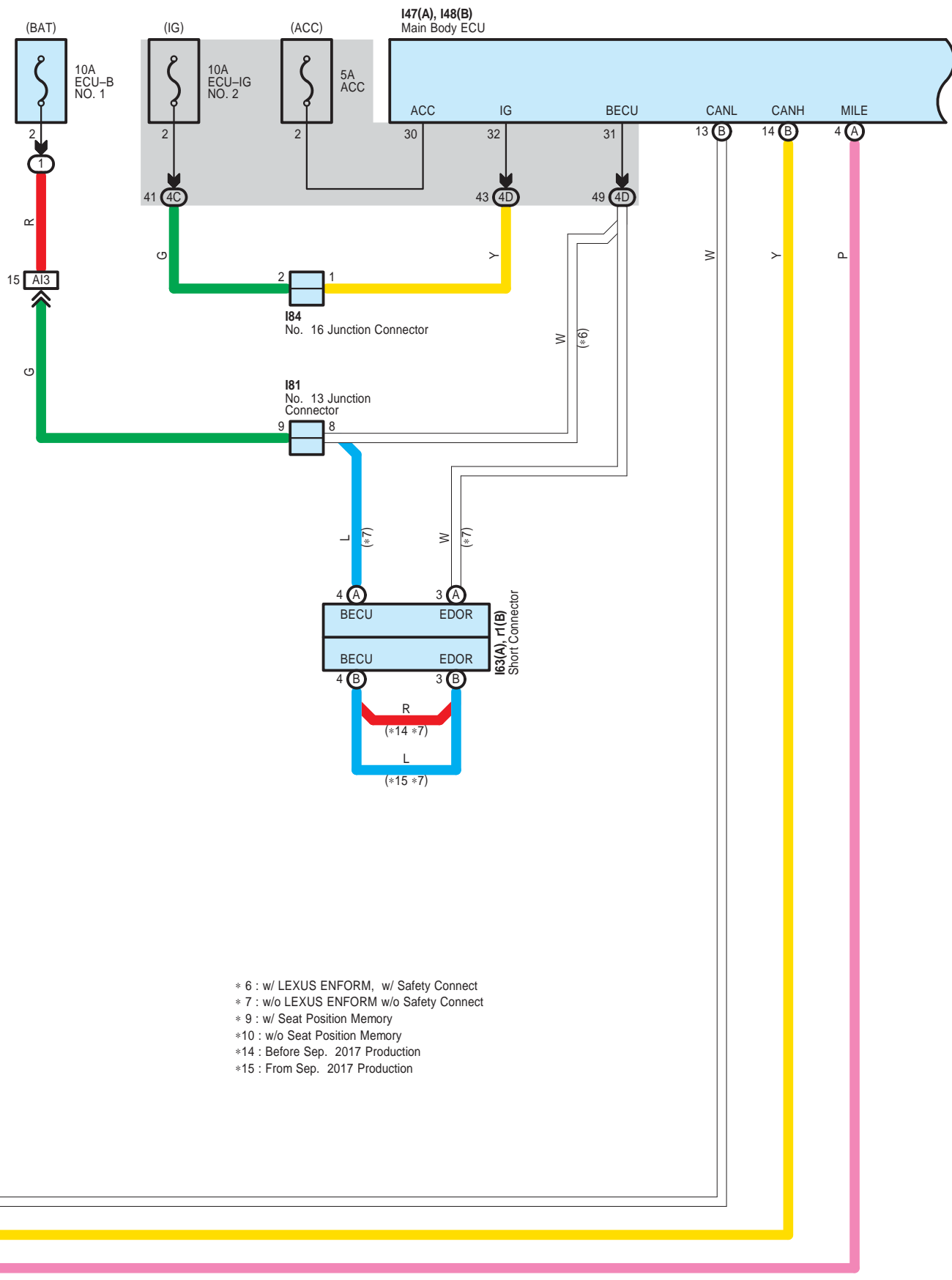

Back Door Opener (w/o Power Back Door), Immobiliser System, Smart Access System with Push-Button Start, Starting, Steering Lock, Wireless Door Lock Control

I47(A), I48(B)
Main Body ECU

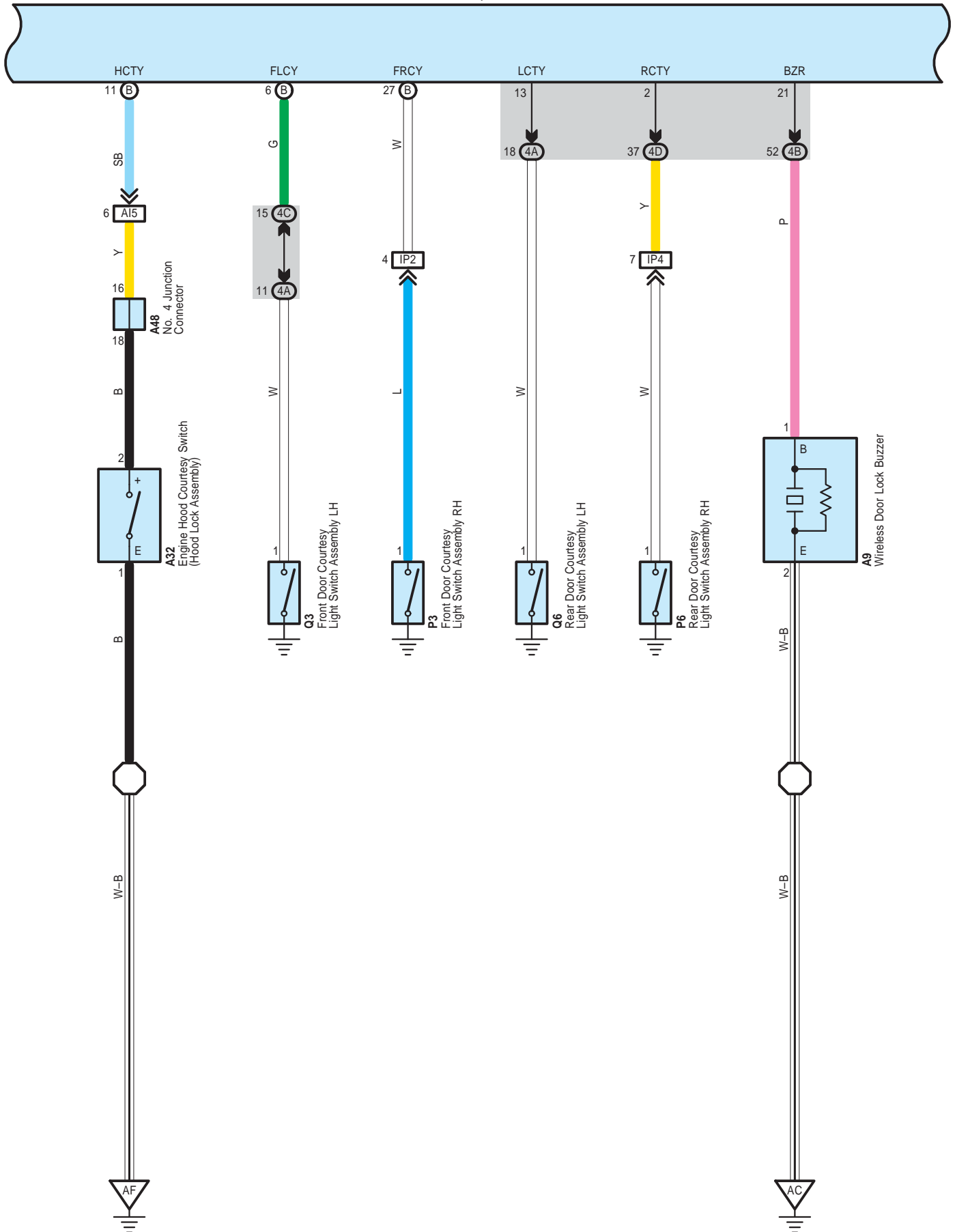

Back Door Opener (w/o Power Back Door), Immobiliser System, Smart Access System with Push-Button Start, Starting, Steering Lock, Wireless Door Lock Control

I47(A), I48(B)
Main Body ECU

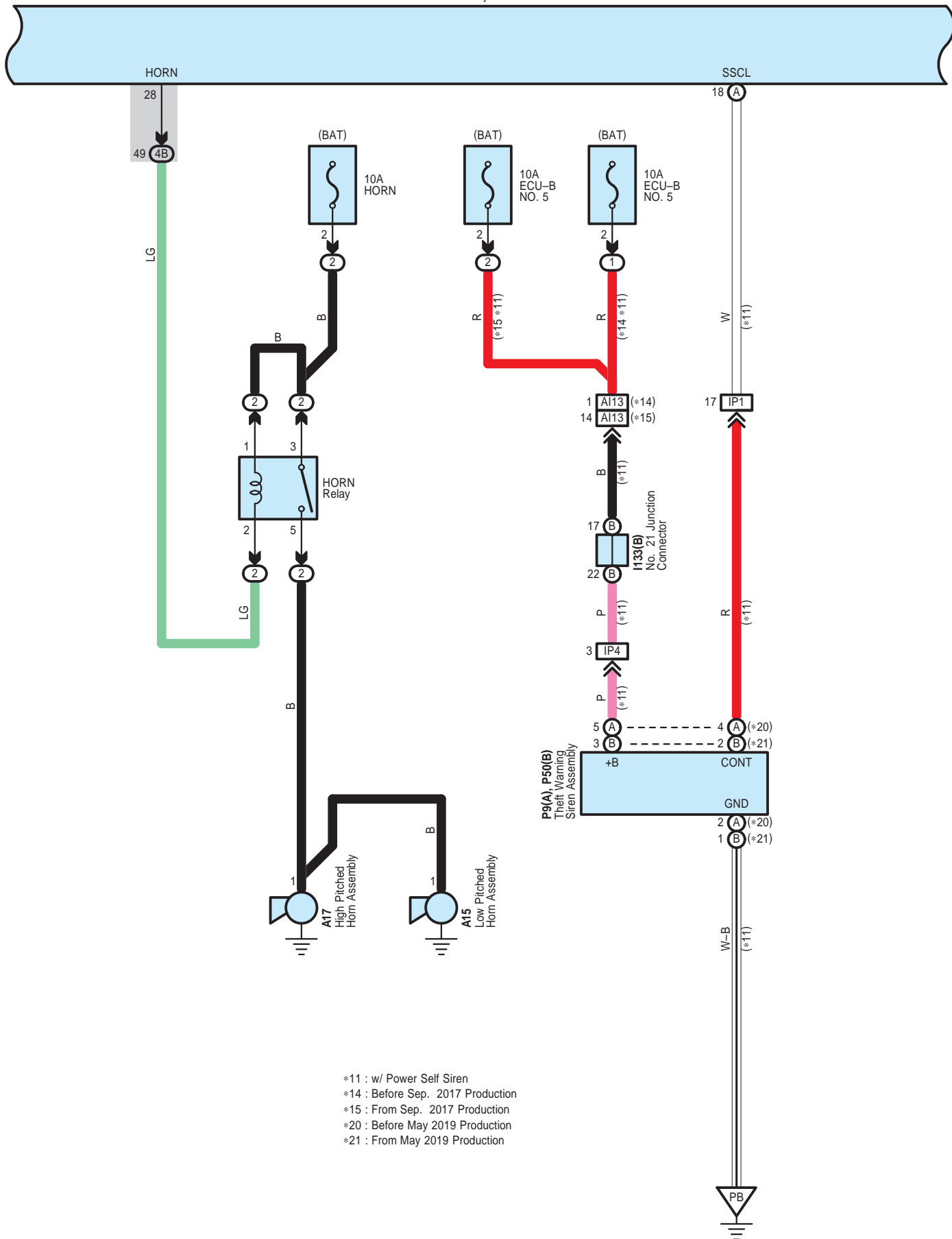

- *11 : w/ Power Self Siren
- *14 : Before Sep. 2017 Production
- *15 : From Sep. 2017 Production
- *20 : Before May 2019 Production
- *21 : From May 2019 Production

Back Door Opener (w/o Power Back Door), Immobiliser System, Smart Access System with Push-Button Start, Starting, Steering Lock, Wireless Door Lock Control

I47(A), I48(B)
Main Body ECU

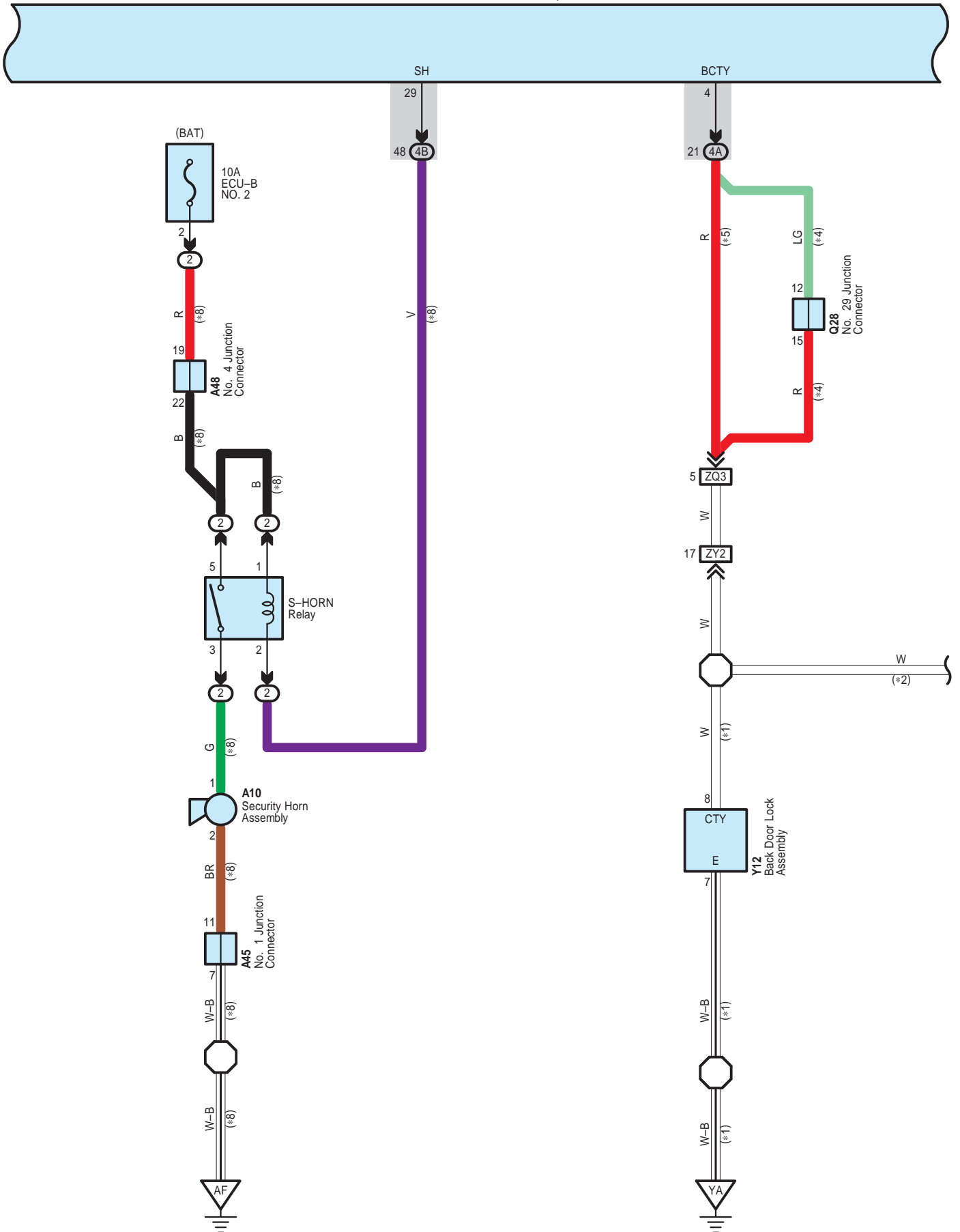

Back Door Opener (w/o Power Back Door), Immobiliser System, Smart Access System with Push-Button Start, Starting, Steering Lock, Wireless Door Lock Control

I47(A), I48(B)
Main Body ECU

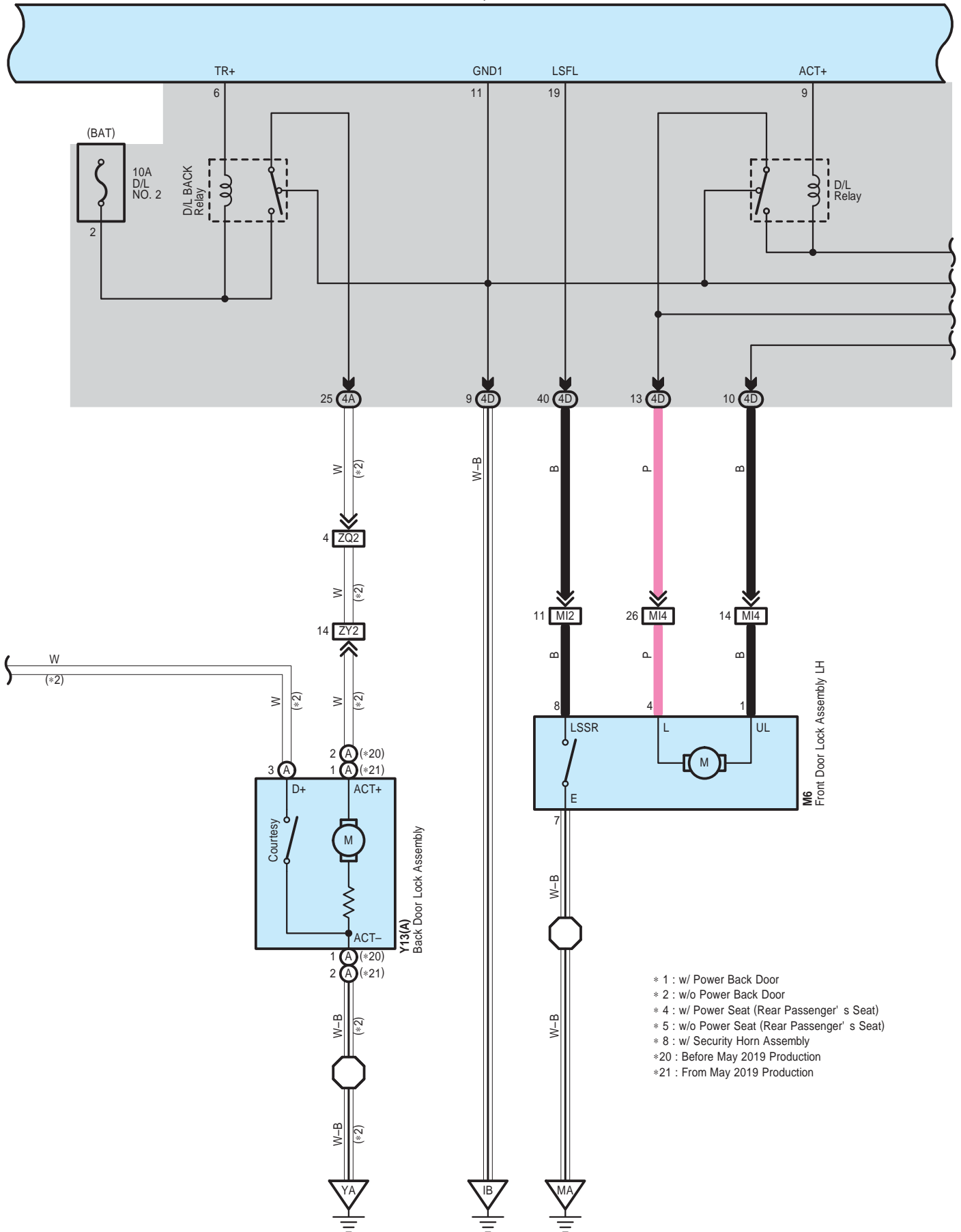

- * 1 : w/ Power Back Door
- * 2 : w/o Power Back Door
- * 4 : w/ Power Seat (Rear Passenger' s Seat)
- * 5 : w/o Power Seat (Rear Passenger' s Seat)
- * 8 : w/ Security Horn Assembly
- * 20 : Before May 2019 Production
- * 21 : From May 2019 Production

Back Door Opener (w/o Power Back Door), Immobiliser System, Smart Access System with Push-Button Start, Starting, Steering Lock, Wireless Door Lock Control

I47(A), I48(B)
Main Body ECU

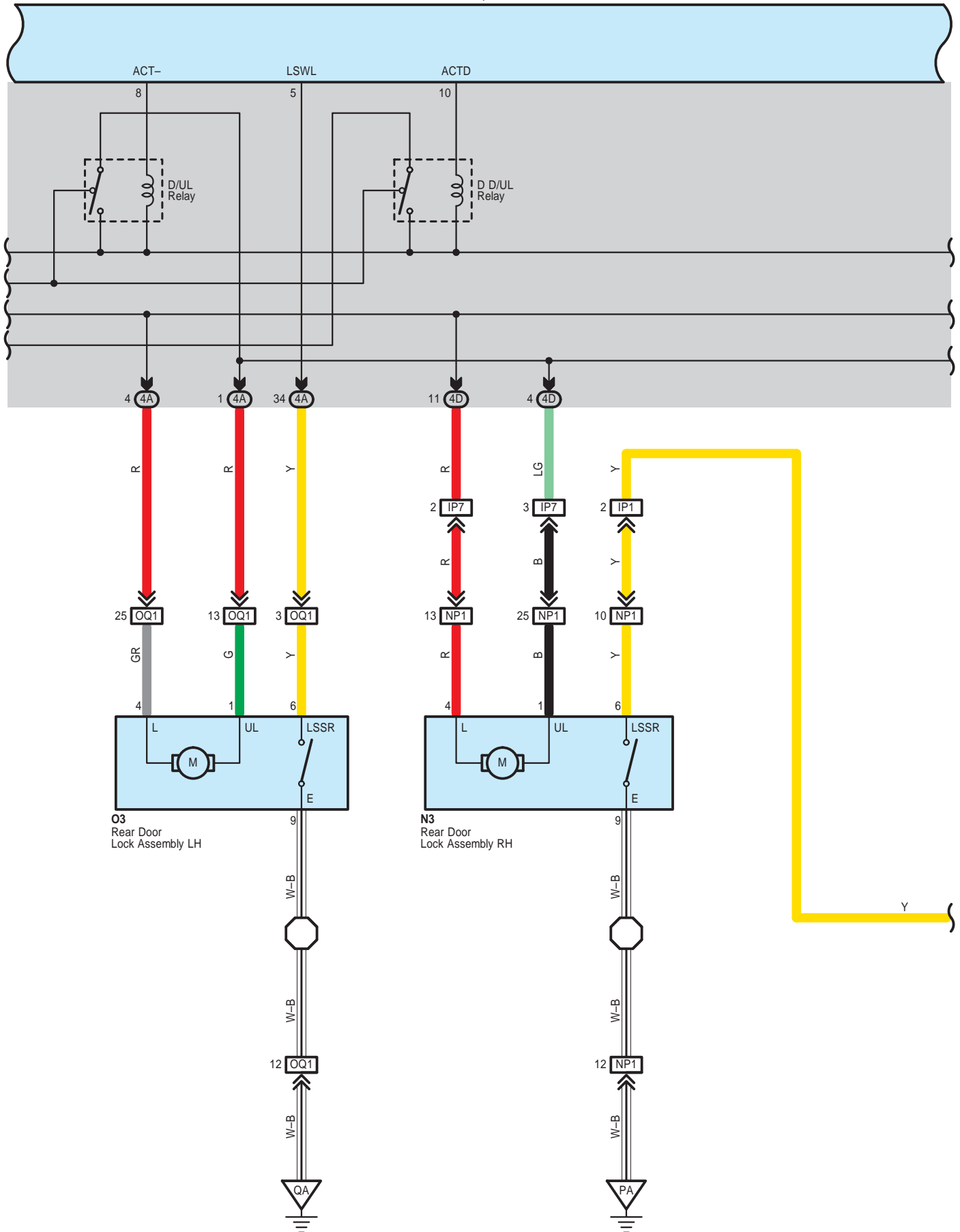

Back Door Opener (w/o Power Back Door), Immobiliser System, Smart Access System with Push-Button Start, Starting, Steering Lock, Wireless Door Lock Control

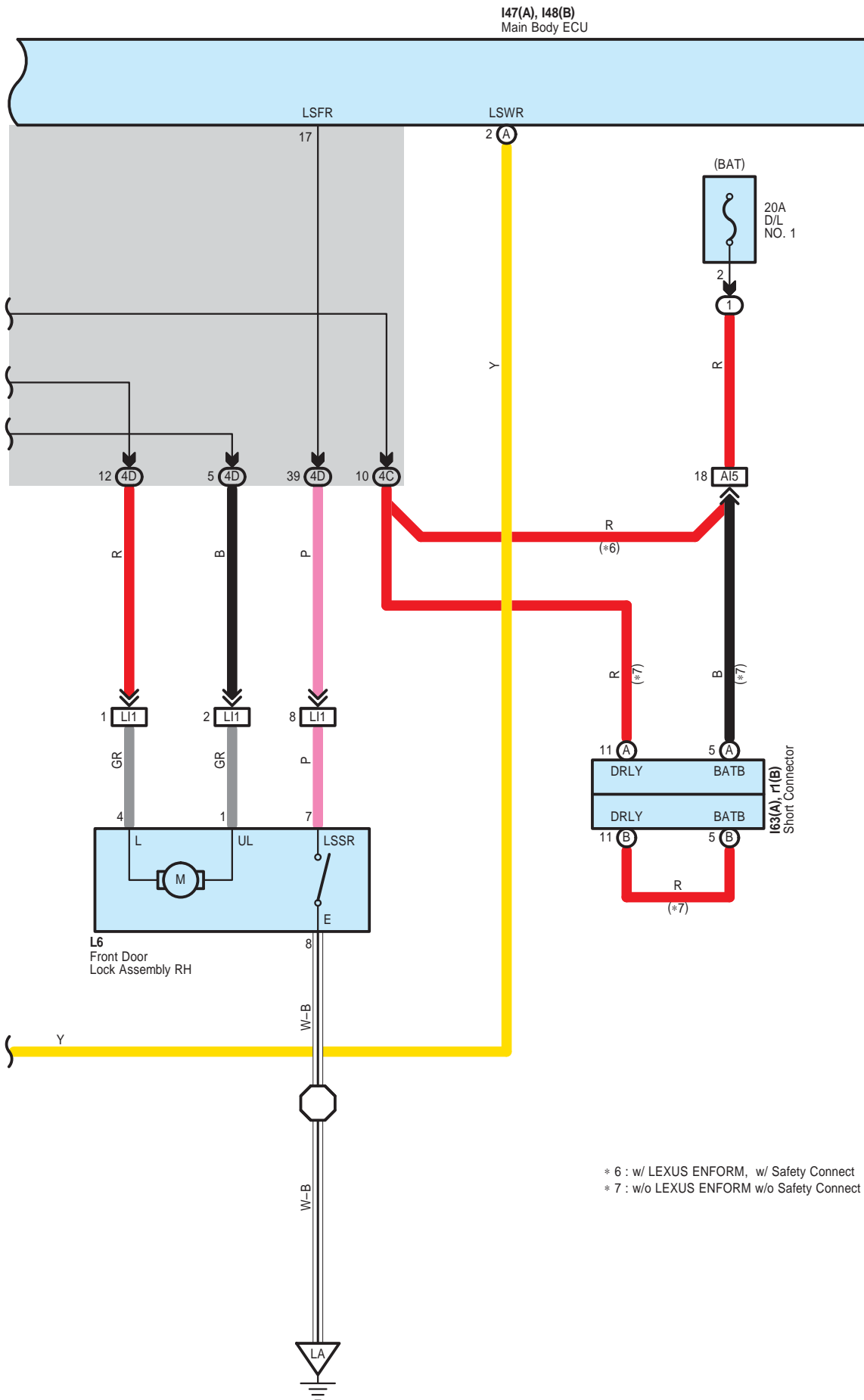

Back Door Opener (w/o Power Back Door), Immobiliser System, Smart Access System with Push-Button Start, Starting, Steering Lock, Wireless Door Lock Control

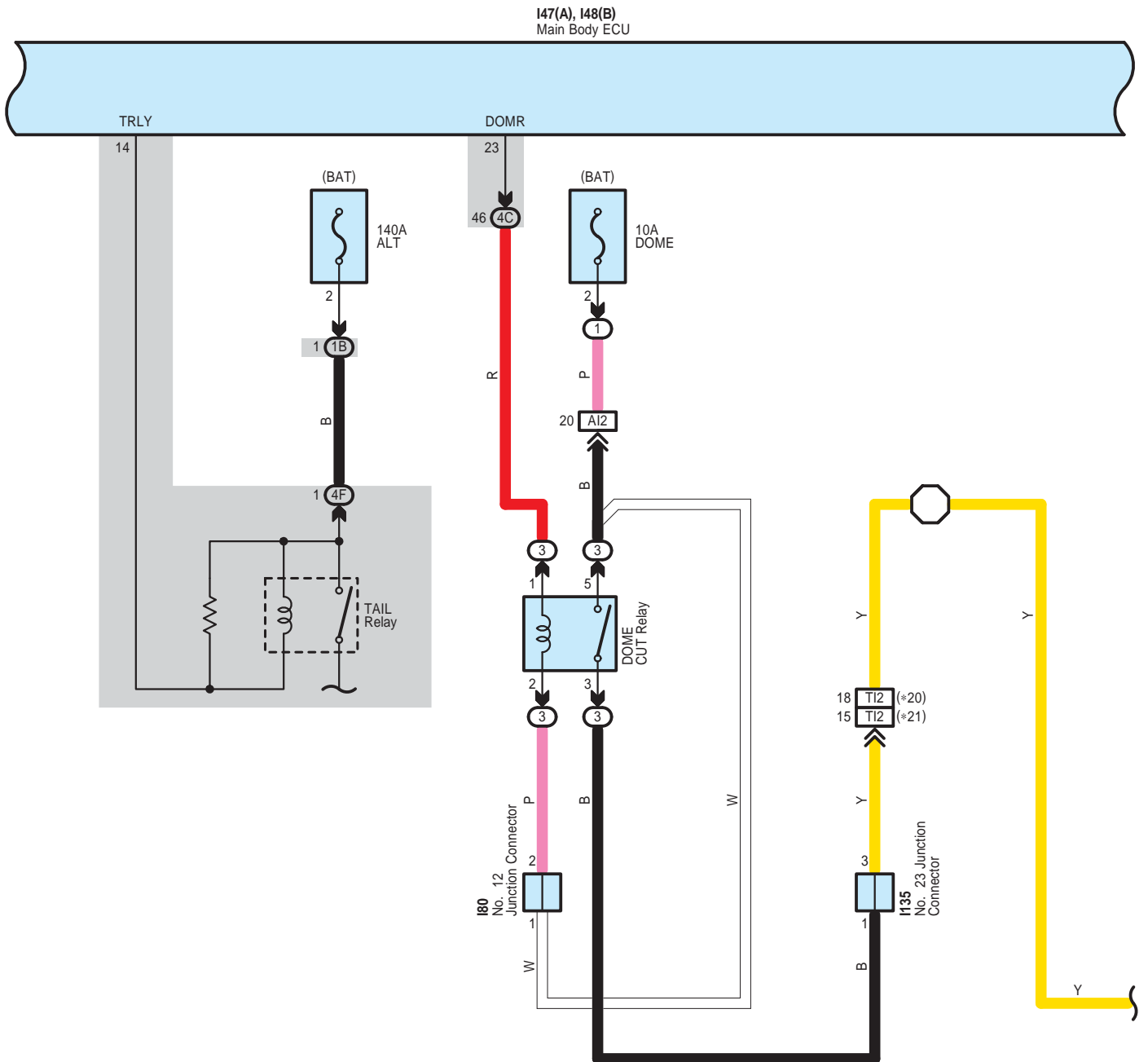

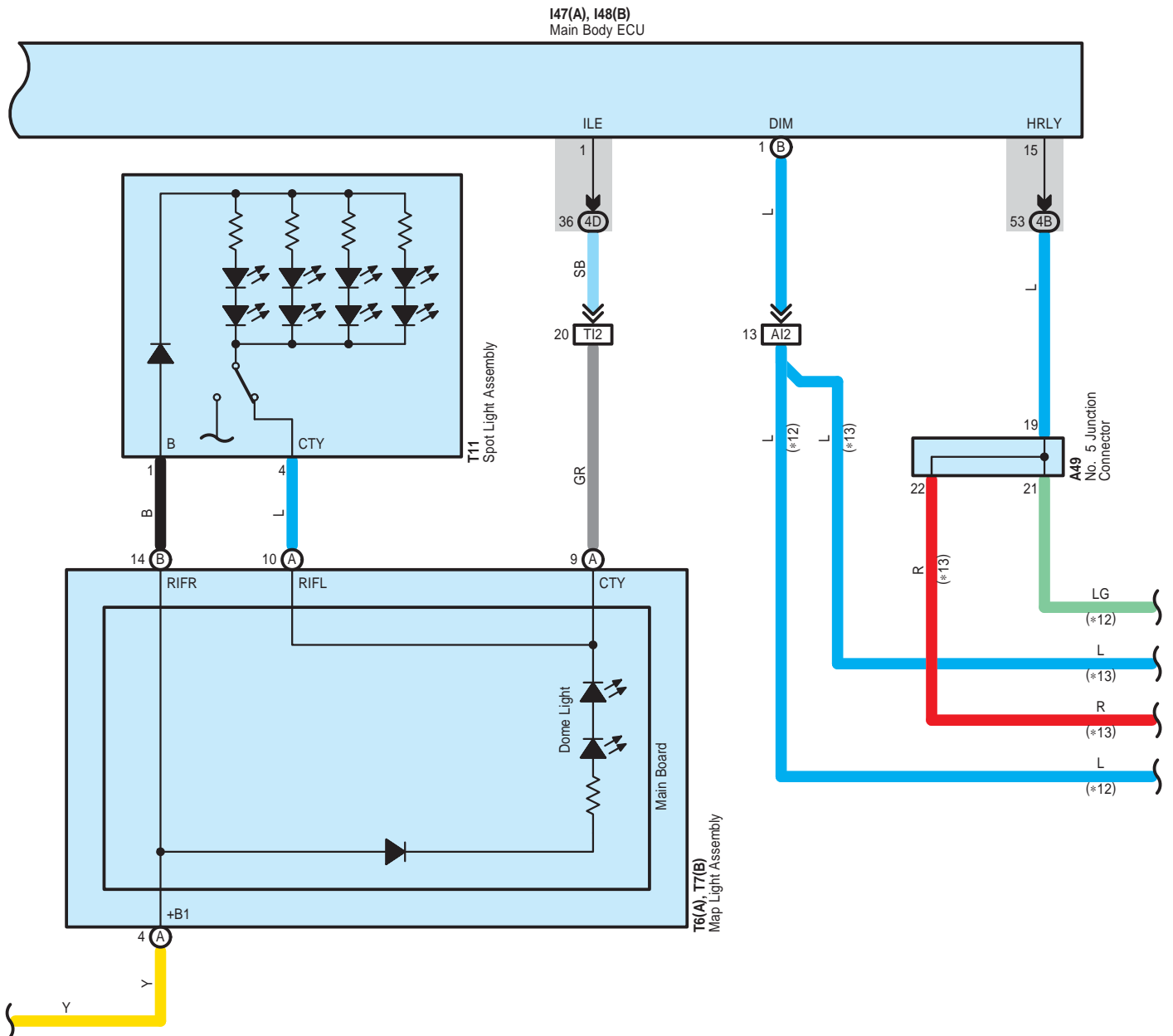

- *12 : w/ Headlight Light Control ECU Sub-Assembly
- *13 : w/o Headlight Light Control ECU Sub-Assembly
- *20 : Before May 2019 Production
- *21 : From May 2019 Production

Back Door Opener (w/o Power Back Door), Immobiliser System, Smart Access System with Push-Button Start, Starting, Steering Lock, Wireless Door Lock Control

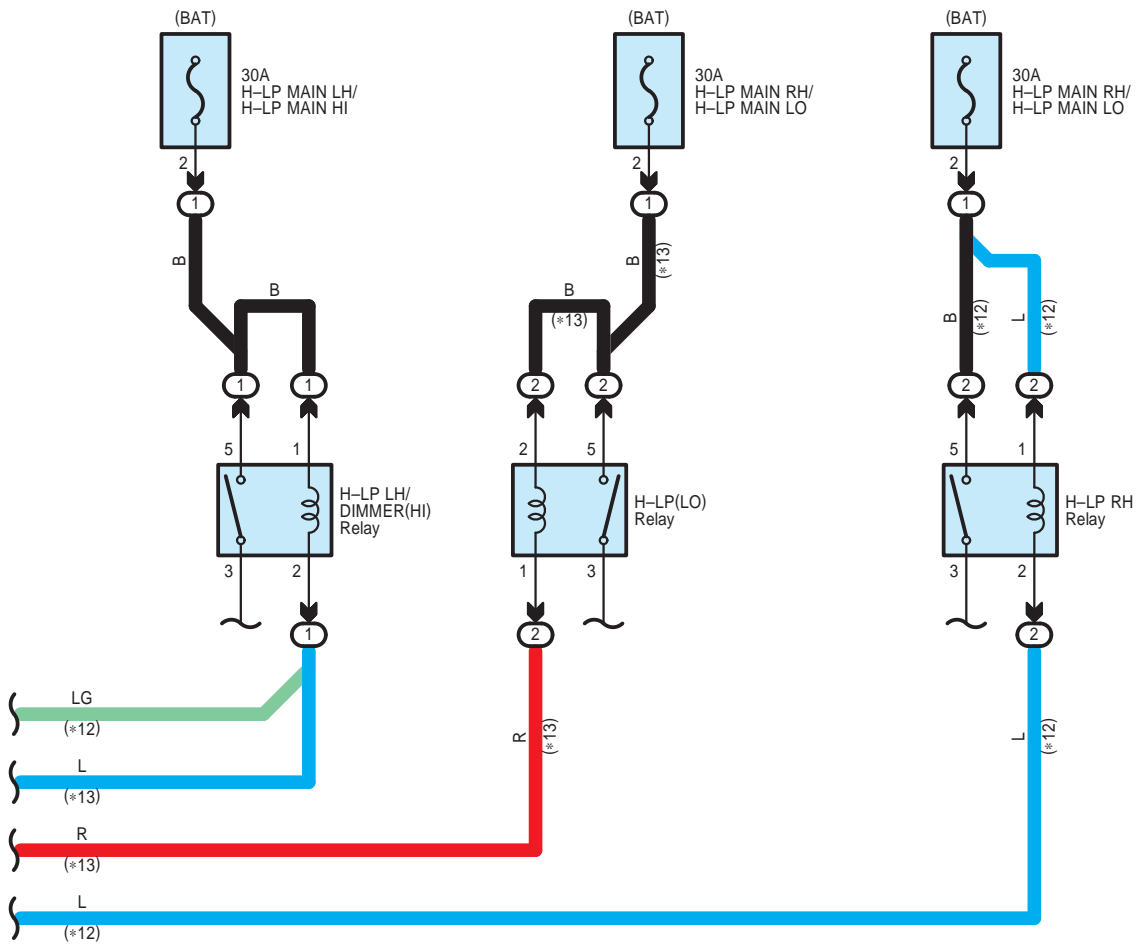

*12 : w/ Headlight Light Control ECU Sub-Assembly
 *13 : w/o Headlight Light Control ECU Sub-Assembly

Back Door Opener (w/o Power Back Door), Immobiliser System, Smart Access System with Push-Button Start, Starting, Steering Lock, Wireless Door Lock Control

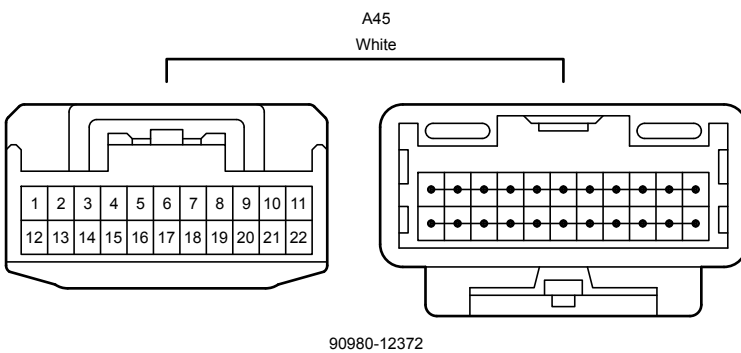
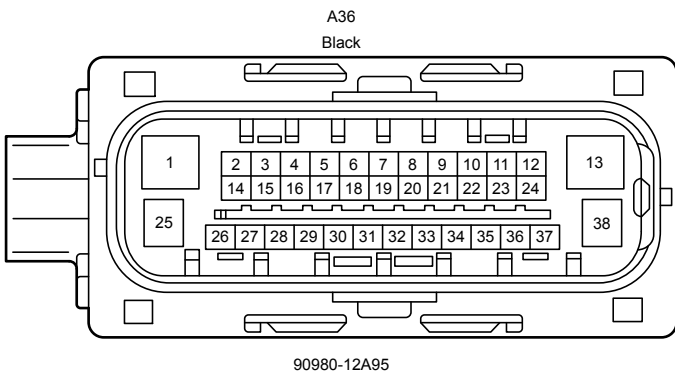
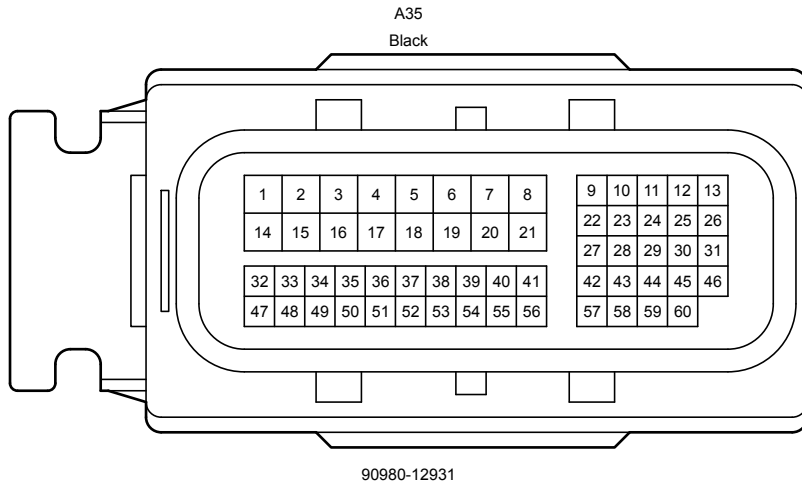
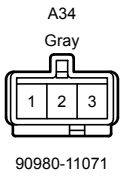
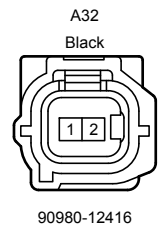
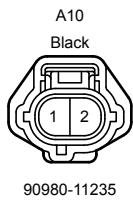
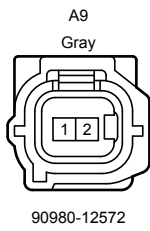
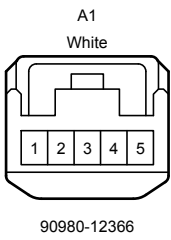

Back Door Opener (w/o Power Back Door), Immobiliser System, Smart Access System with Push-Button Start, Starting, Steering Lock, Wireless Door Lock Control

A47
White

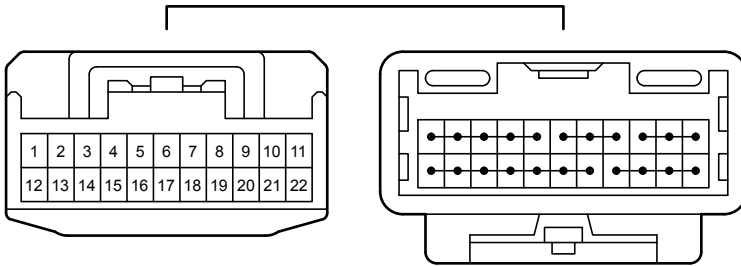

90980-12372

A48
Blue

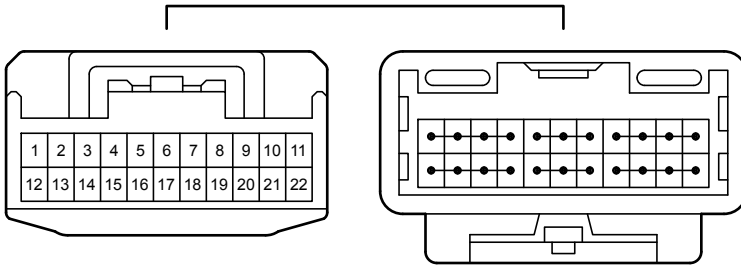

90980-12372

A49
White

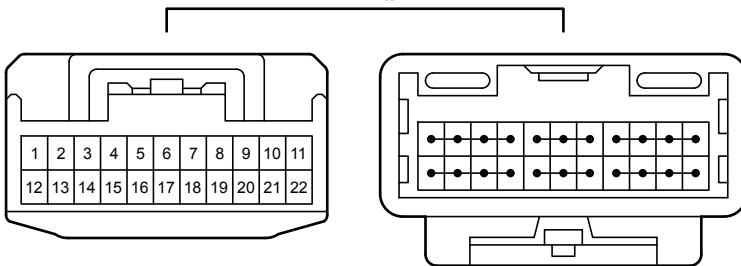

90980-12372

C14
Black

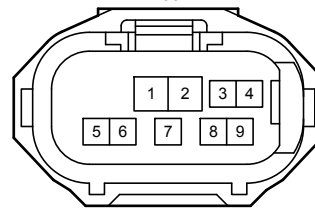

90980-12A23

C20
Black

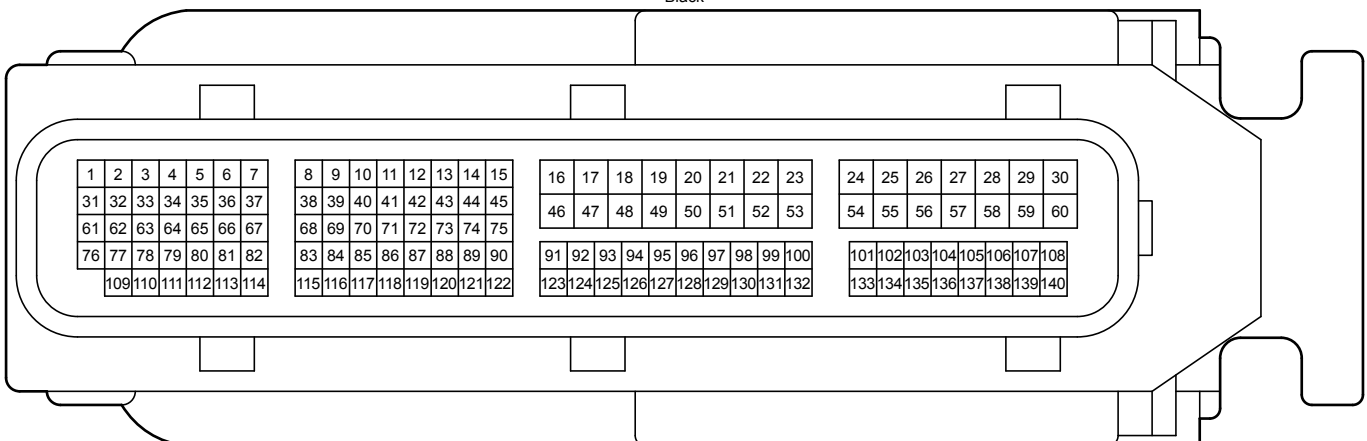

90980-12836

Back Door Opener (w/o Power Back Door), Immobiliser System, Smart Access System with Push-Button Start, Starting, Steering Lock, Wireless Door Lock Control

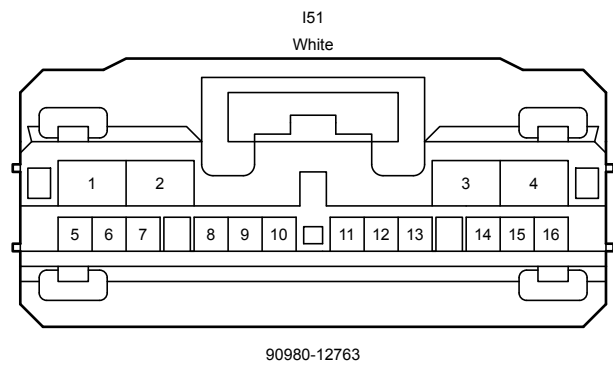
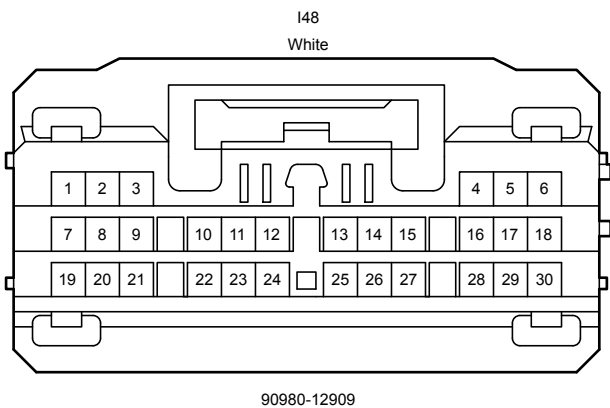
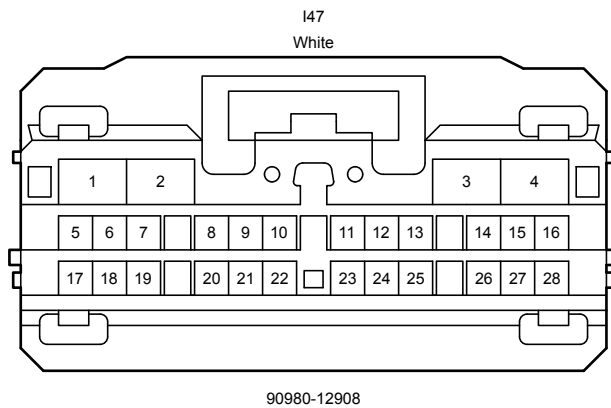
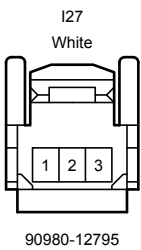
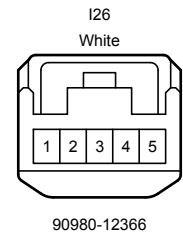
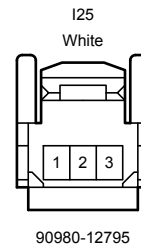
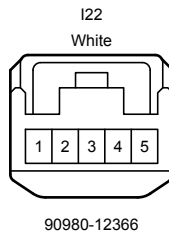
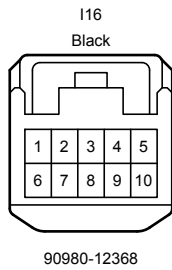
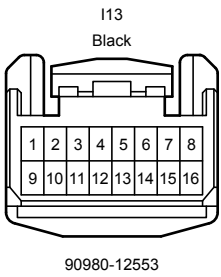
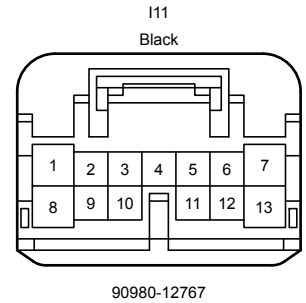
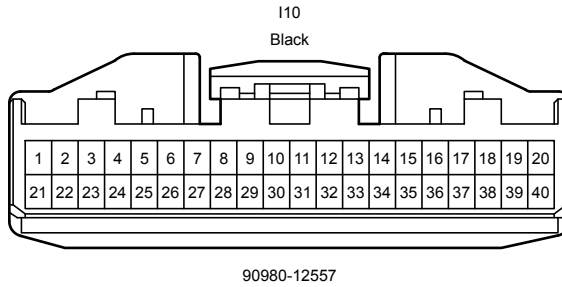
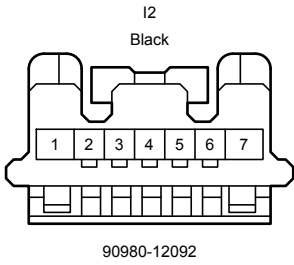
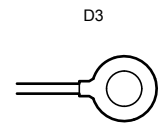
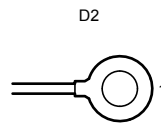
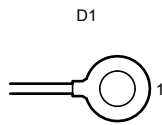
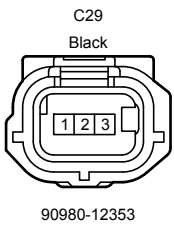

Back Door Opener (w/o Power Back Door), Immobiliser System, Smart Access System with Push-Button Start, Starting, Steering Lock, Wireless Door Lock Control

I52
Black

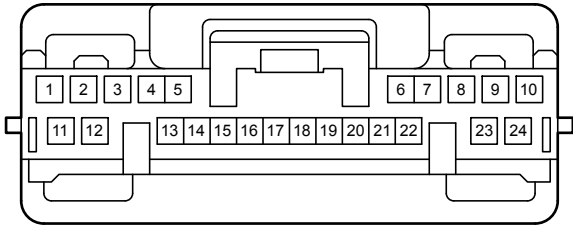

90980-12912

I53
Black

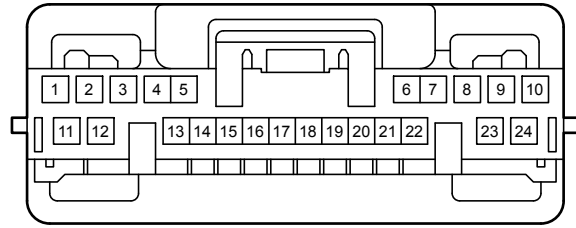

90980-12A42

I63
Gray

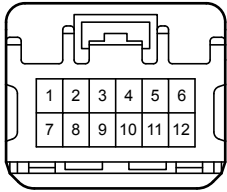

90980-12737

I73
White

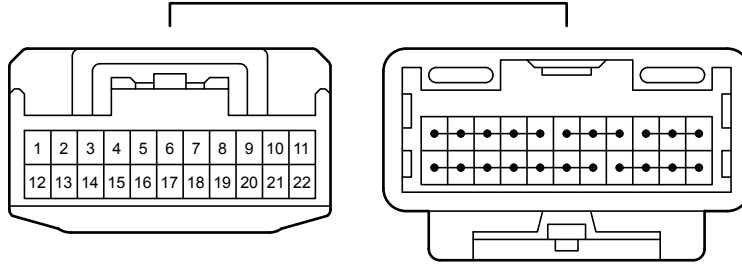

90980-12372

I75
Gray

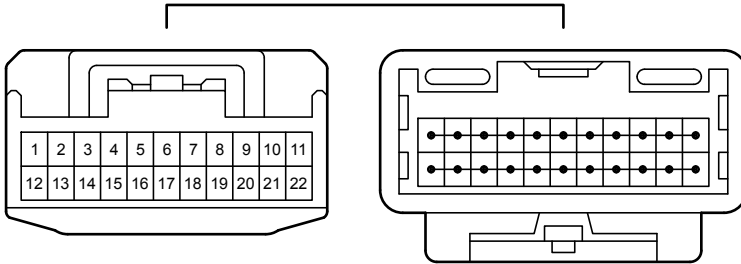

90980-12372
(Before Sep. 2017 Production)

I75
White

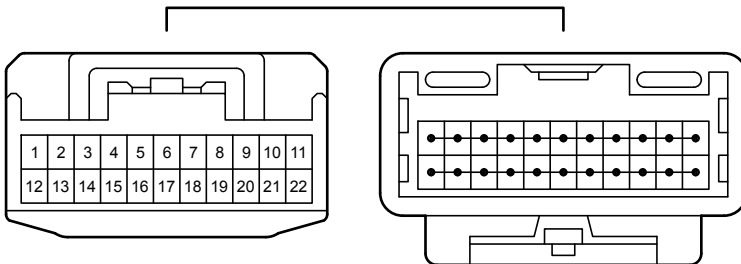

90980-12372
(From Sep. 2017 Production)

I76
Blue

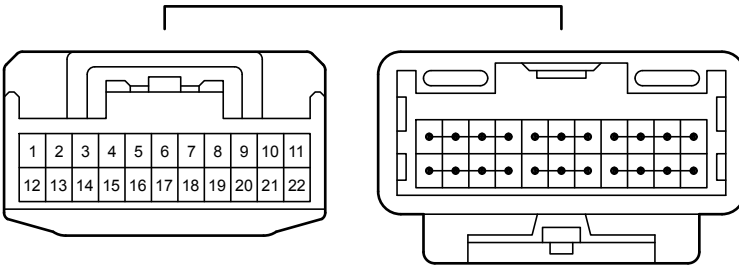

90980-12372

I77
Gray

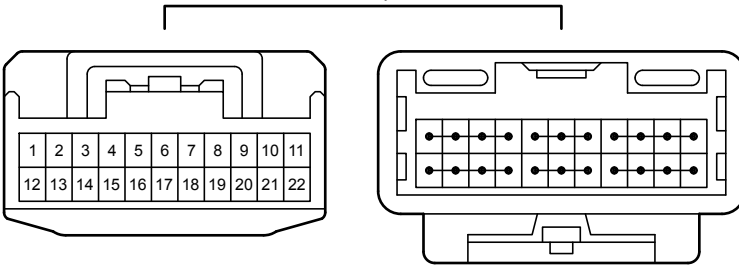

90980-12372

I80
White

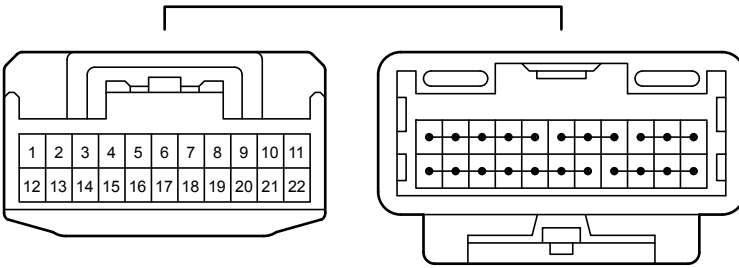

90980-12372

I81
Gray

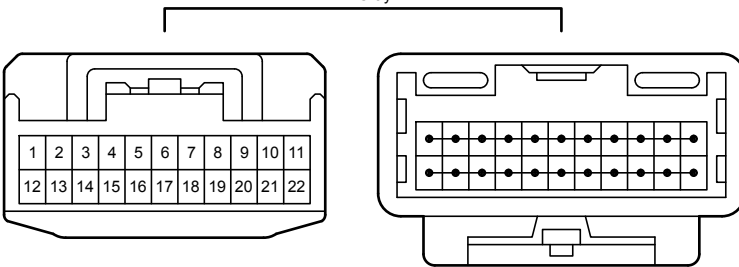

90980-12372

Back Door Opener (w/o Power Back Door), Immobiliser System, Smart Access System with Push-Button Start, Starting, Steering Lock, Wireless Door Lock Control

I82
Blue

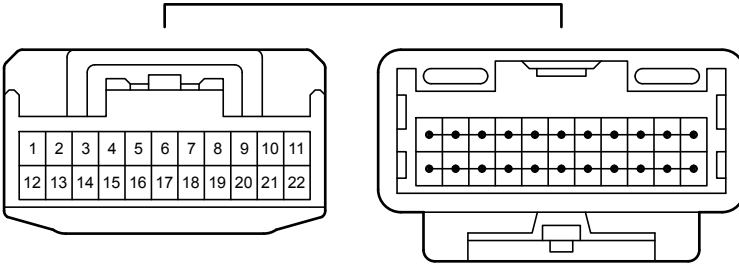

90980-12372

I84
Black

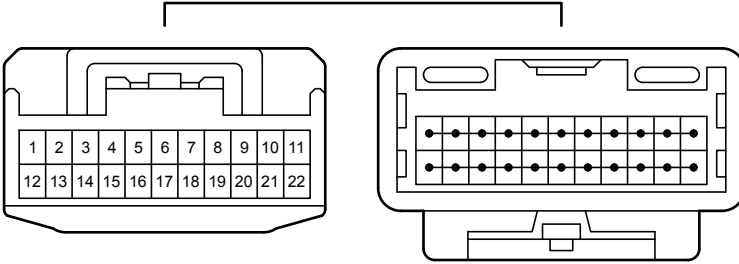

90980-12372
(Before May 2019 Production)

I84
Gray

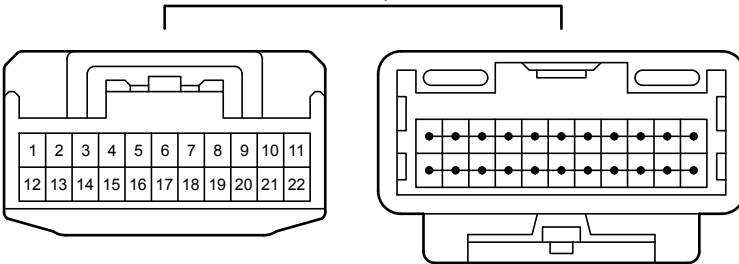

90980-12372
(From May 2019 Production)

I85
White

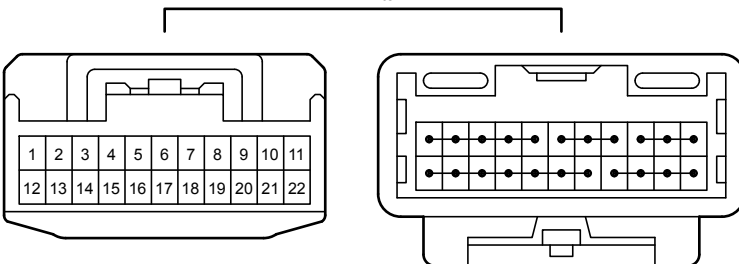

90980-12372

Back Door Opener (w/o Power Back Door), Immobiliser System, Smart Access System with Push-Button Start, Starting, Steering Lock, Wireless Door Lock Control

I93
White

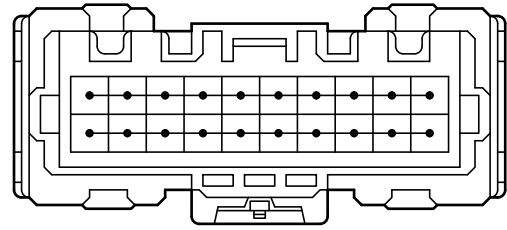
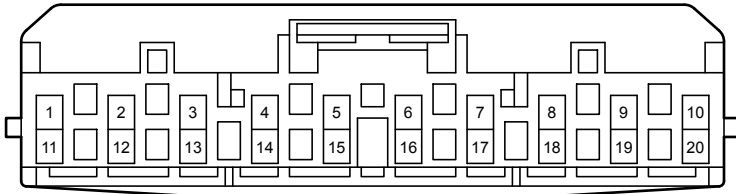

90980-12A58

I94
White

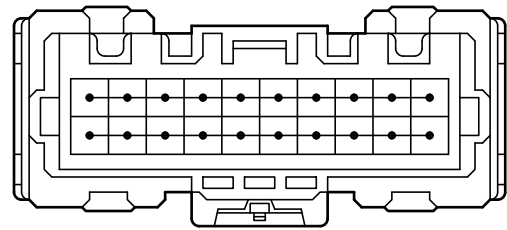
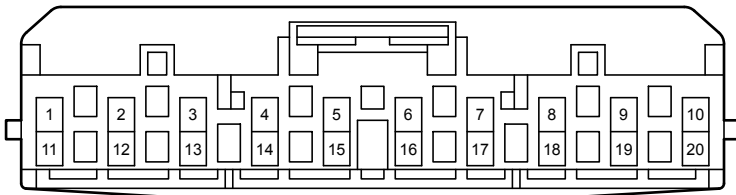

90980-12A58

I133
White

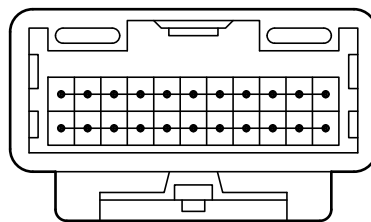
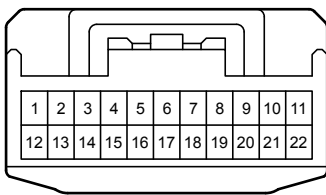

90980-12372

I135
Gray

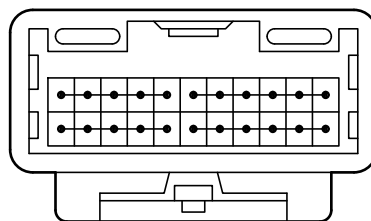
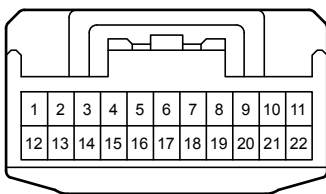

90980-12372

Back Door Opener (w/o Power Back Door), Immobiliser System, Smart Access System with Push-Button Start, Starting, Steering Lock, Wireless Door Lock Control

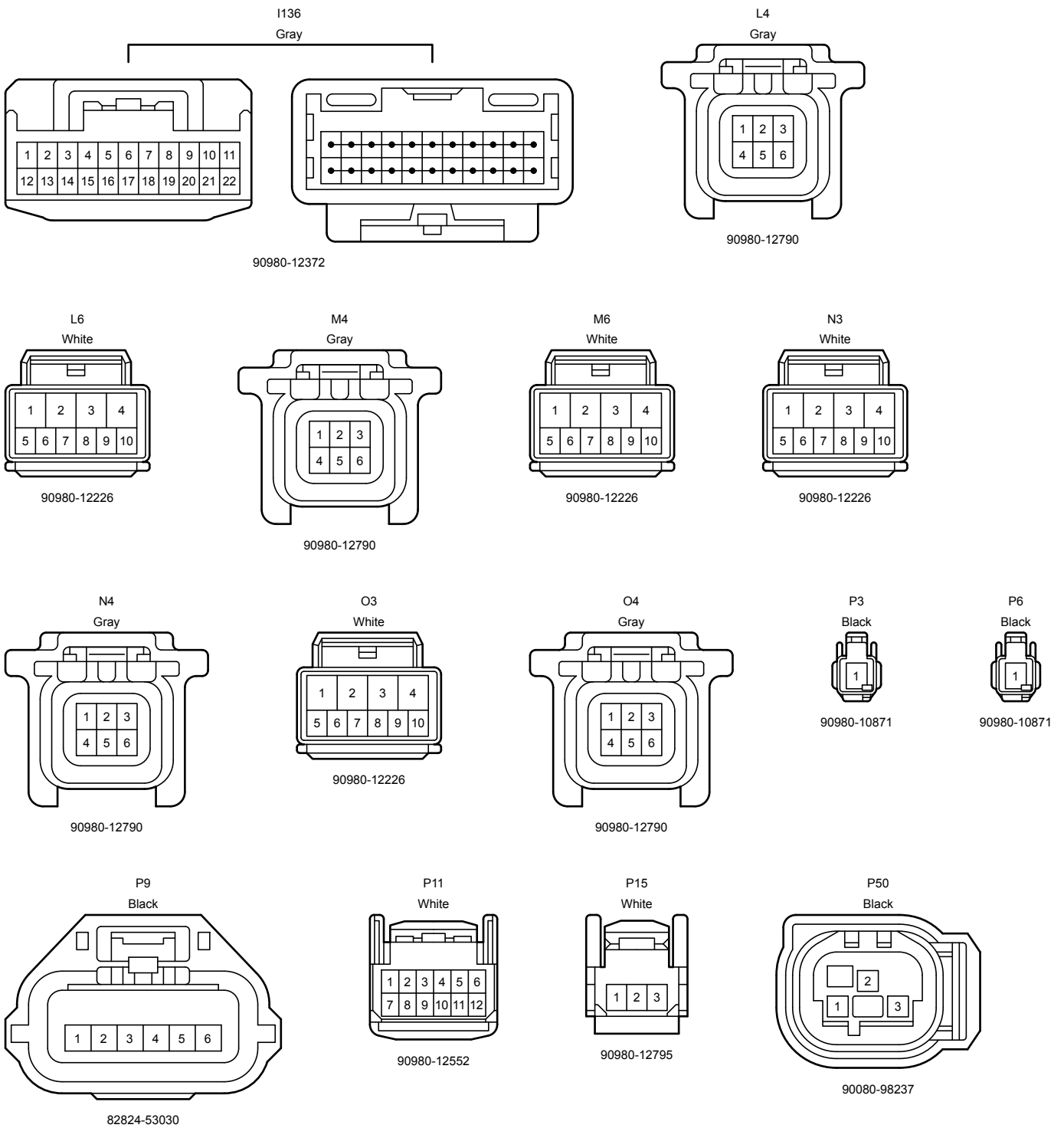

Back Door Opener (w/o Power Back Door), Immobiliser System, Smart Access System with Push-Button Start, Starting, Steering Lock, Wireless Door Lock Control

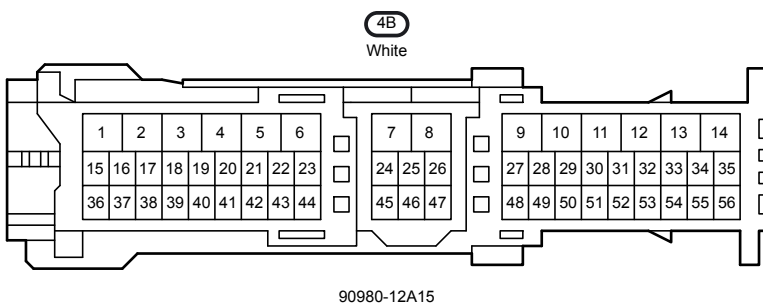
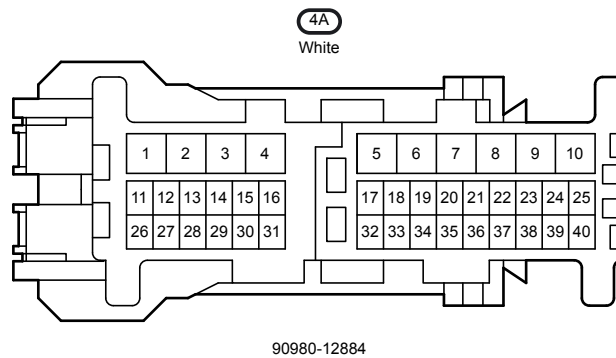
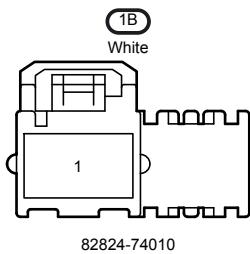
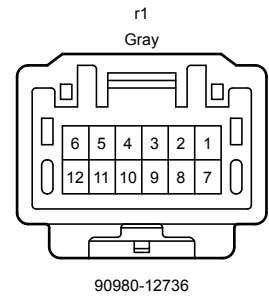
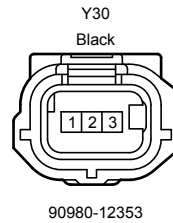
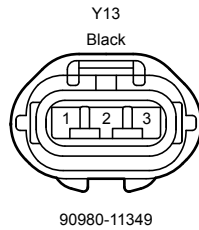
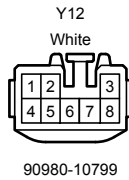
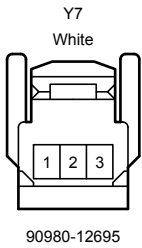
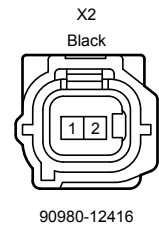
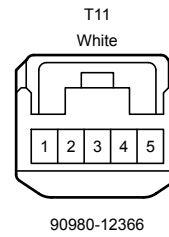
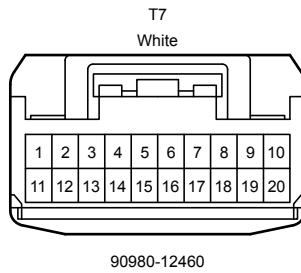
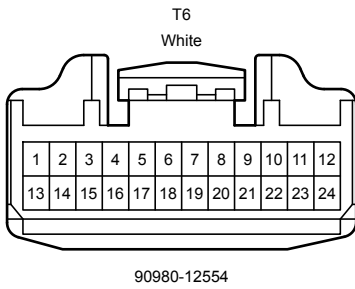
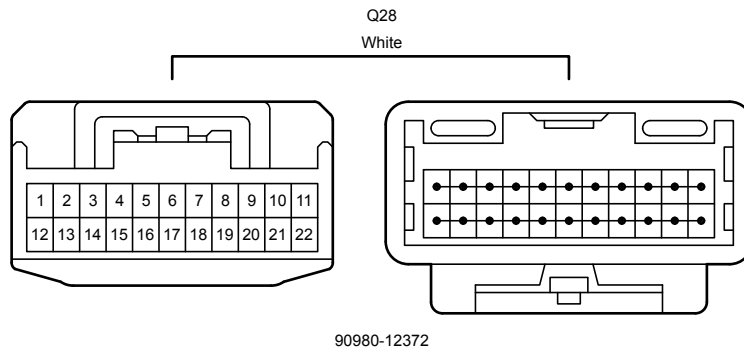

Back Door Opener (w/o Power Back Door), Immobiliser System, Smart Access System with Push-Button Start, Starting, Steering Lock, Wireless Door Lock Control

4C

White

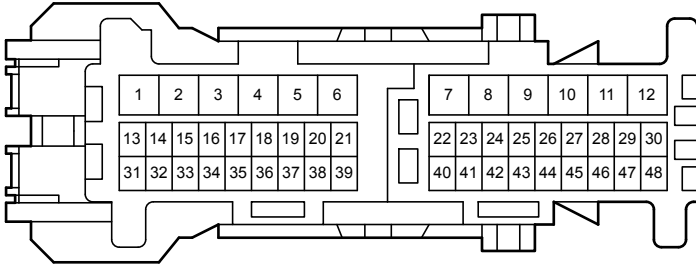

90980-12887

4D

White

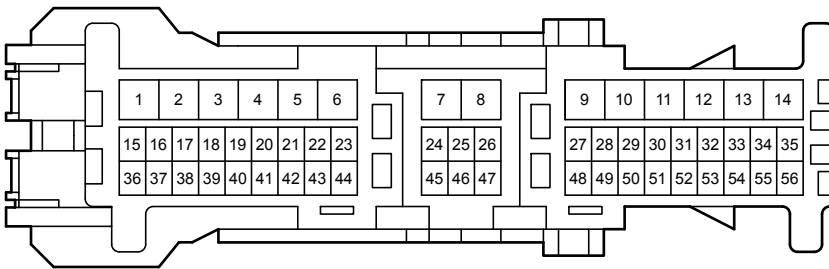

90980-12890

4F

White

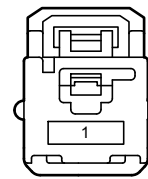

90980-12756

A12

Black

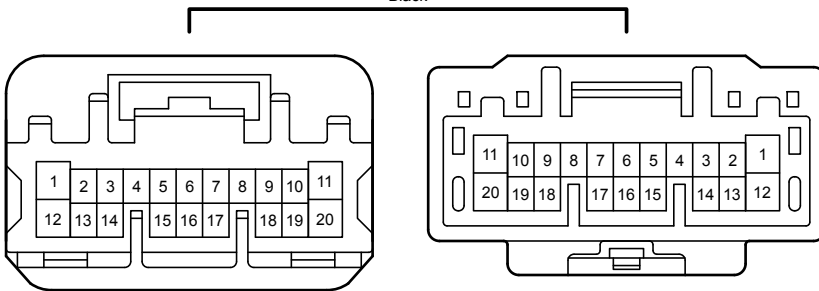

90980-12741

90980-12740

A13

White

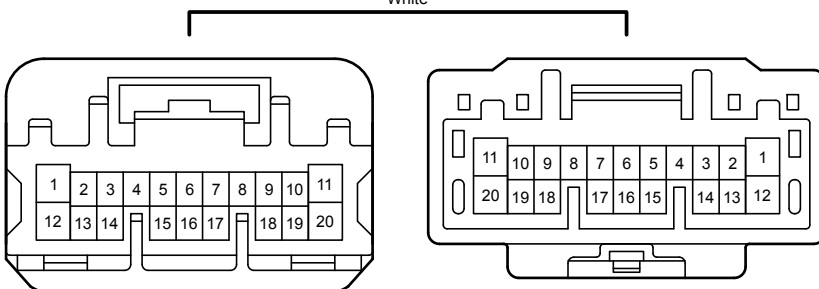

90980-12741

90980-12740

Back Door Opener (w/o Power Back Door), Immobiliser System, Smart Access System with Push-Button Start, Starting, Steering Lock, Wireless Door Lock Control

A15
White

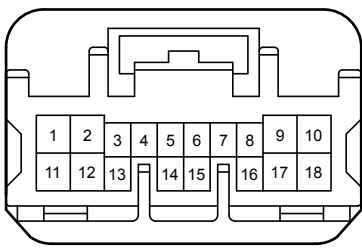

90980-12739

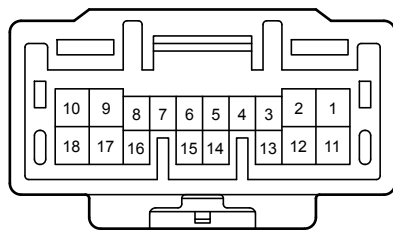

90980-12738

A13
White

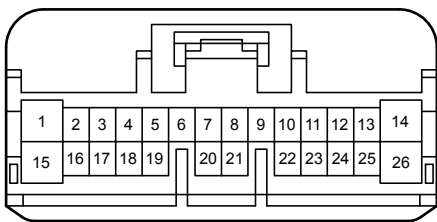

90980-12771

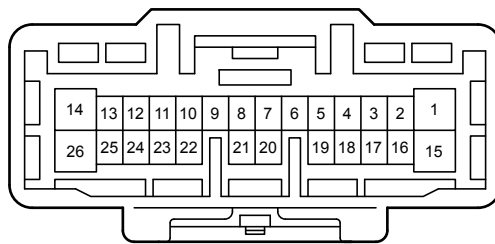

90980-12770

A14
Gray

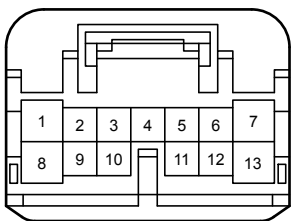

90980-12767

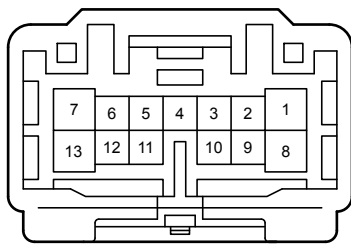

90980-12766

A15
Blue

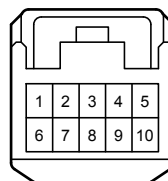

90980-12368

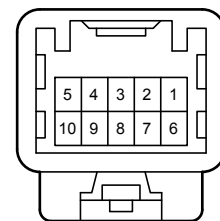

90980-12367

CA1
Blue

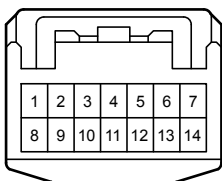

90980-12370

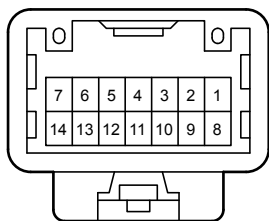

90980-12369

CA2
White

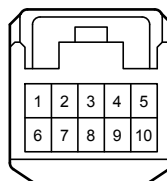

90980-12368

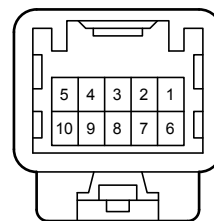

90980-12367

Back Door Opener (w/o Power Back Door), Immobiliser System, Smart Access System with Push-Button Start, Starting, Steering Lock, Wireless Door Lock Control

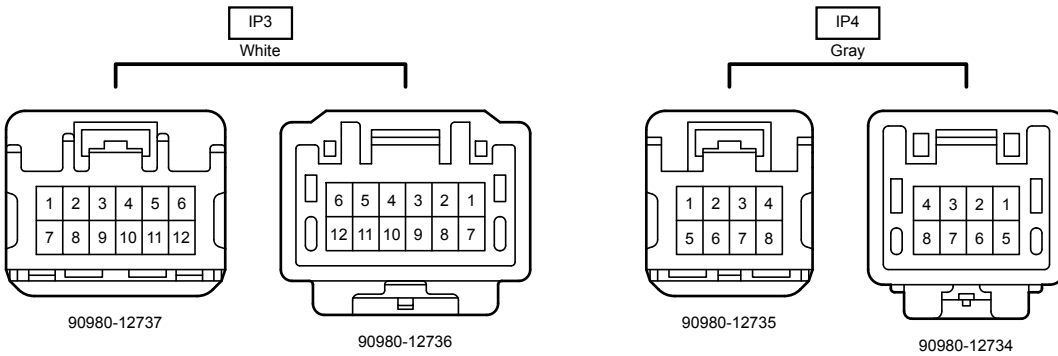
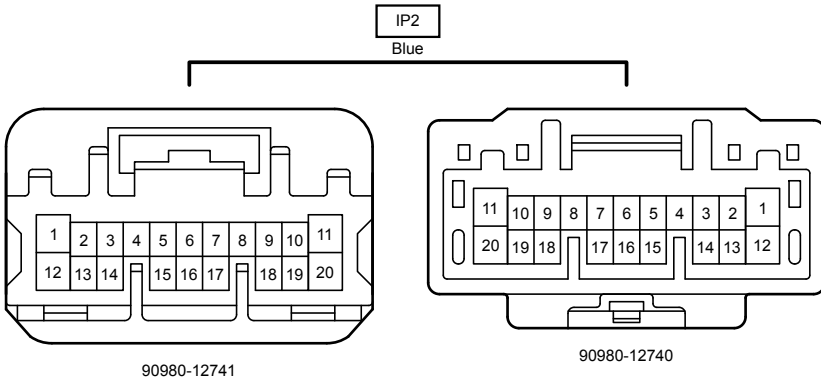
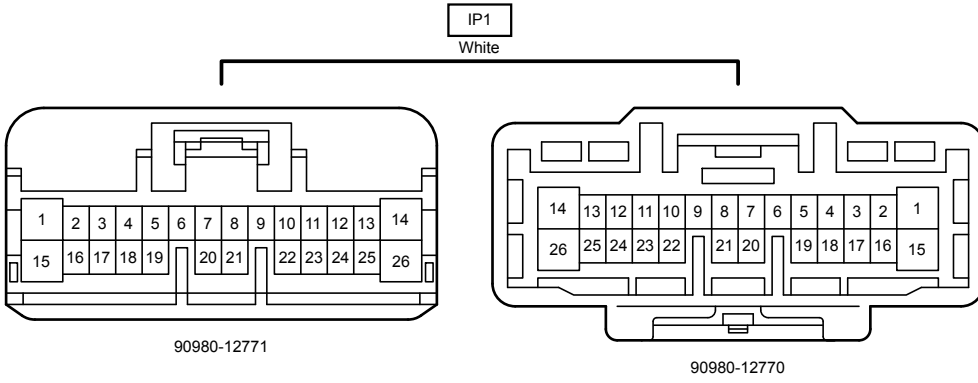
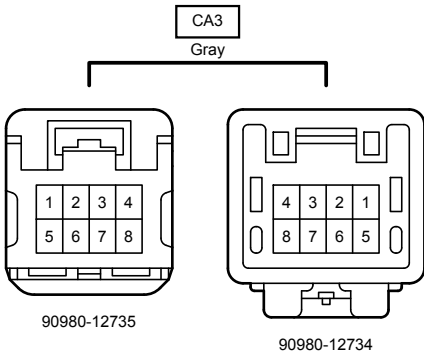

Back Door Opener (w/o Power Back Door), Immobiliser System, Smart Access System with Push-Button Start, Starting, Steering Lock, Wireless Door Lock Control

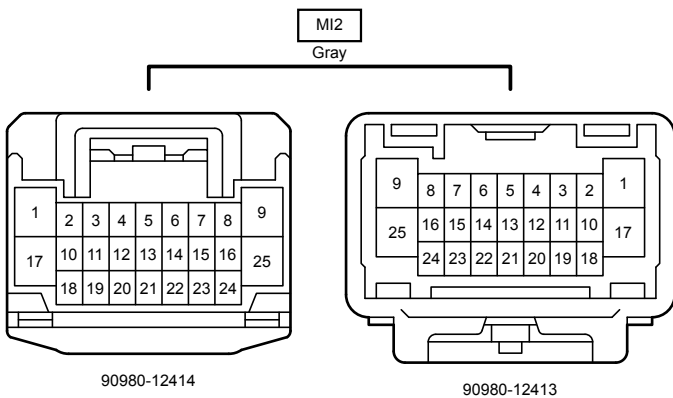
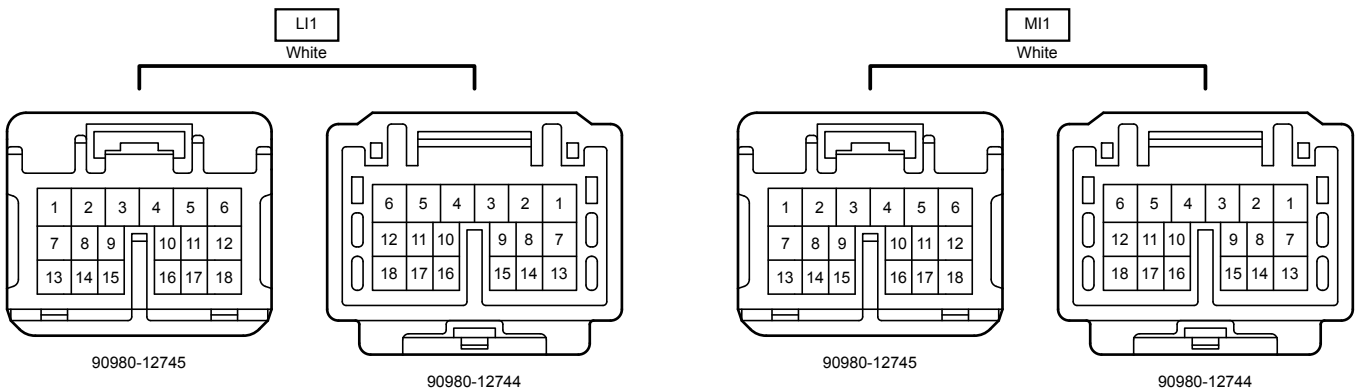
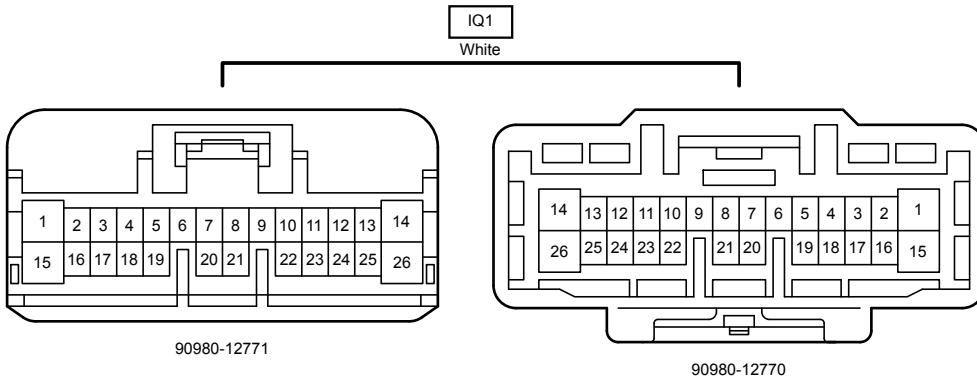
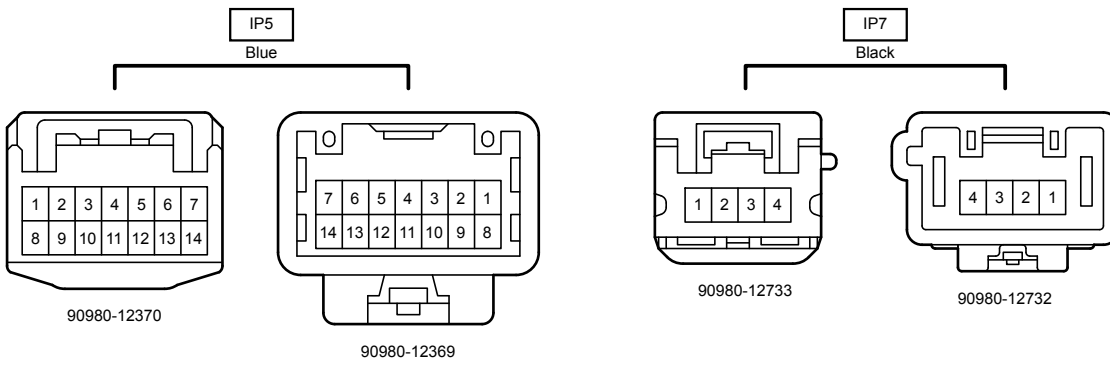

Back Door Opener (w/o Power Back Door), Immobiliser System, Smart Access System with Push-Button Start, Starting, Steering Lock, Wireless Door Lock Control

M14
Black

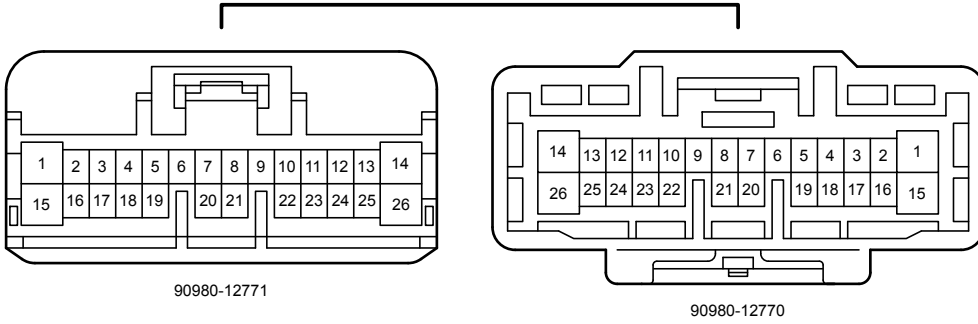

NP1
White

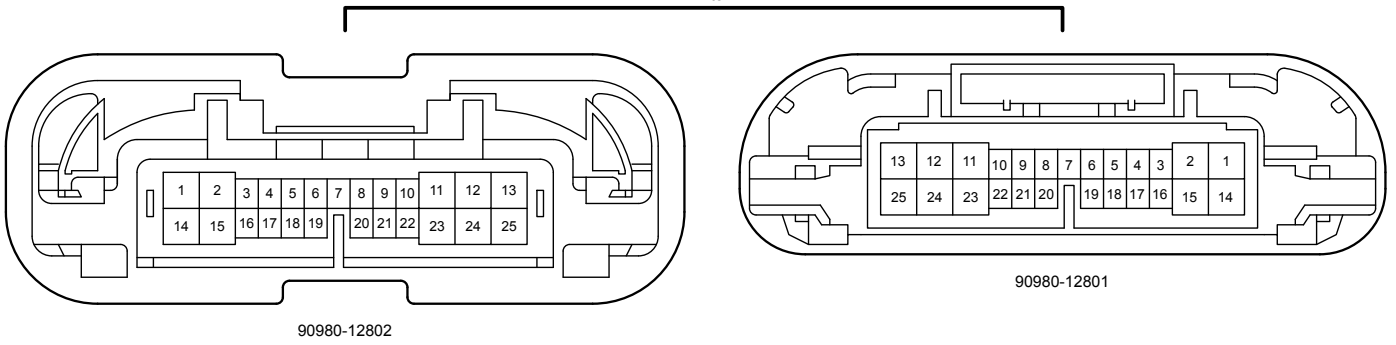

OQ1
White

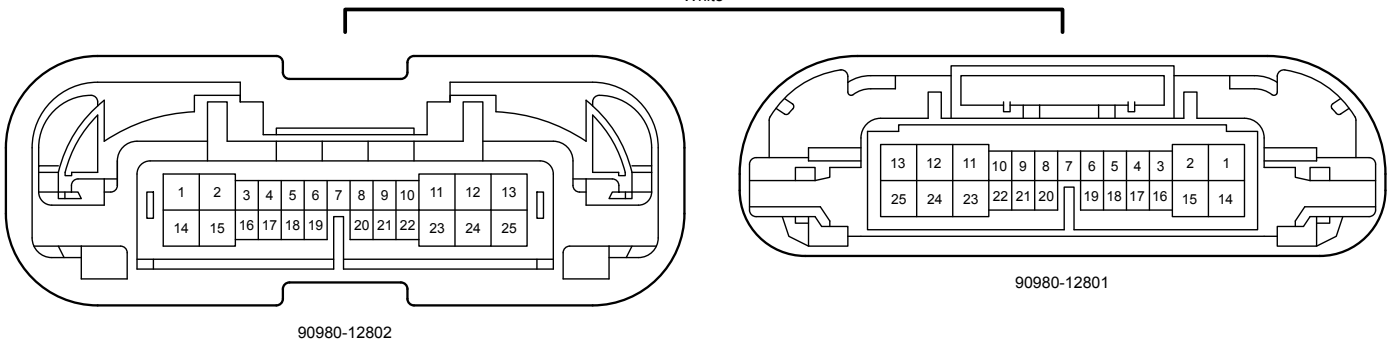

QP1
White

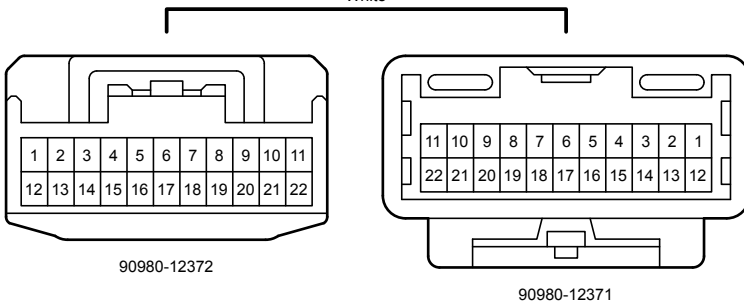

Back Door Opener (w/o Power Back Door), Immobiliser System, Smart Access System with Push-Button Start, Starting, Steering Lock, Wireless Door Lock Control

T12

Black

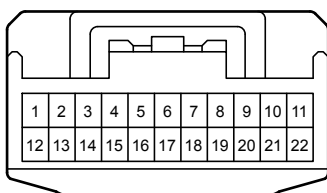

90980-12372

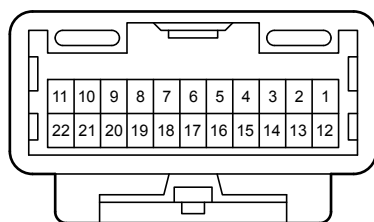

90980-12371

XP1

White

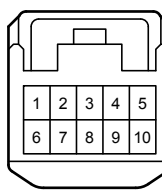

90980-12368

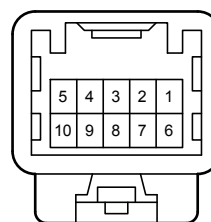

90980-12367

ZQ2

Black

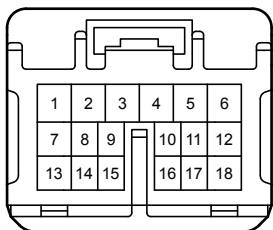

90980-12745

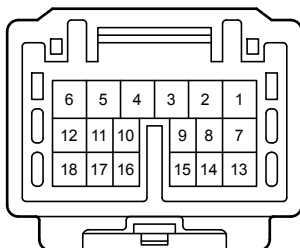

90980-12744

ZQ3

Gray

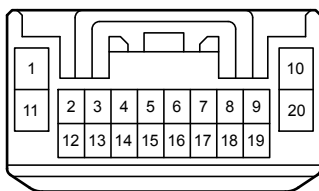

90980-12378

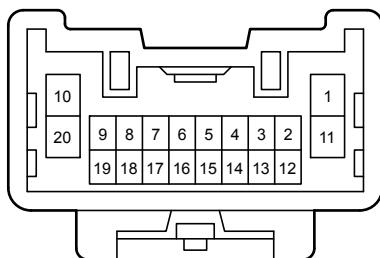

90980-12377

ZY2

Black

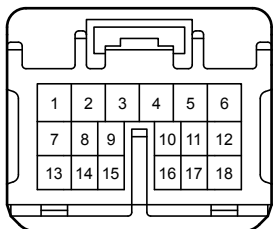

90980-12745

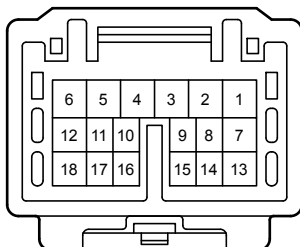

90980-12744