

Position of Parts in Instrument Panel <LHD>

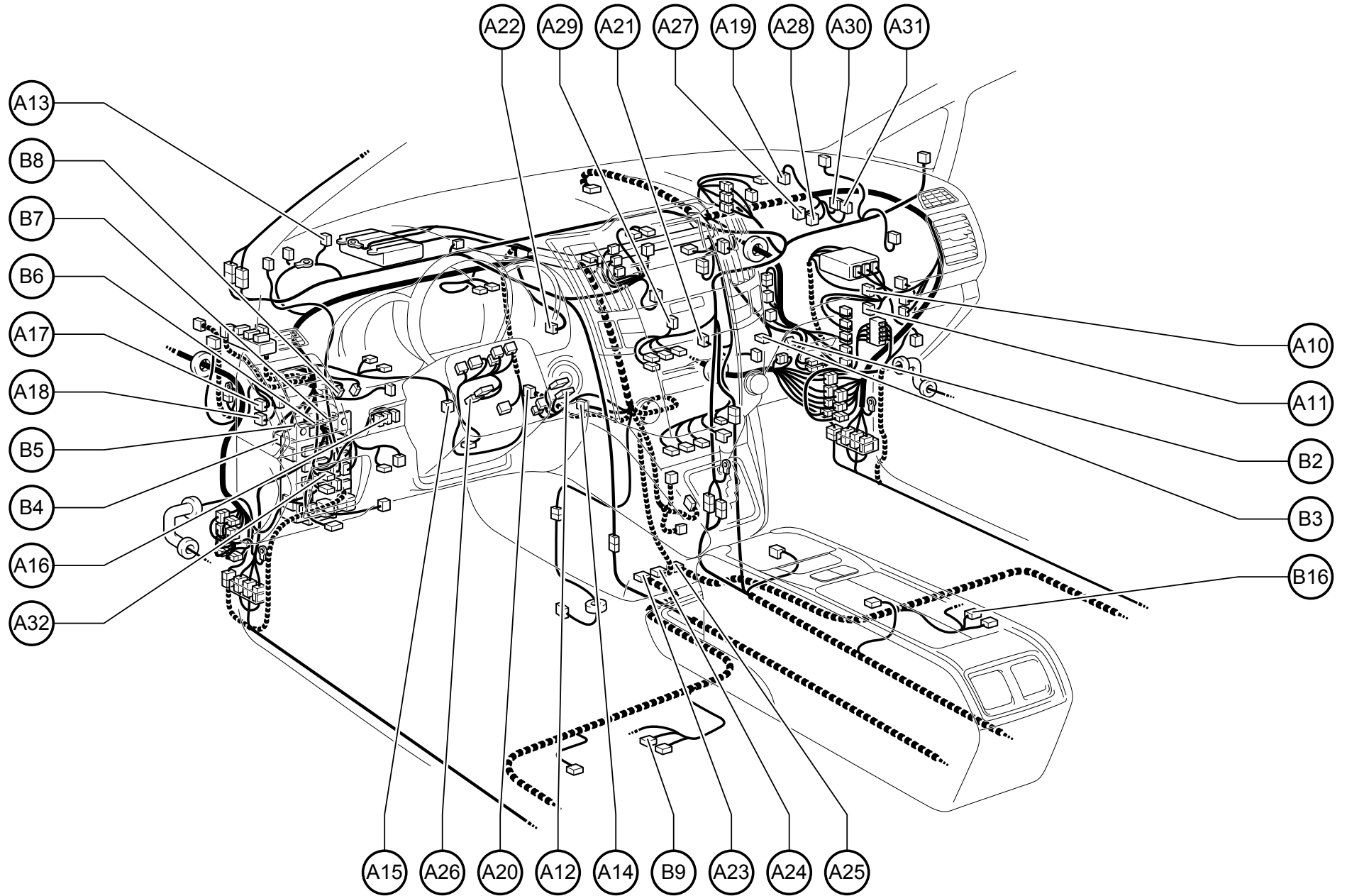

Position of Parts in Instrument Panel <LHD>

---

- A 10 A/C Amplifier
- A 11 A/C Amplifier
- A 12 A/C Room Temp. Sensor
- A 13 A/C Solar Sensor , Automatic Light Control Sensor
- A 14 A/C Thermistor
- A 15 Accel Position Sensor
- A 16 Access Mode SW
- A 17 AFS ECU
- A 18 AFS ECU
- A 19 Air Inlet Control Servo Motor
- A 20 Air Mix Control Servo Motor (Driver Side)
- A 21 Air Mix Control Servo Motor (Front Passenger Side)
- A 22 Air Vent Mode Control Servo Motor
- A 23 Airbag Sensor Assembly
- A 24 Airbag Sensor Assembly
- A 25 Airbag Sensor Assembly
- A 26 Airbag Squib (Steering Wheel Pad)
- A 27 Airbag Squib (Front Passenger Airbag Assembly)
- A 28 Airbag Squib (Front Passenger Airbag Assembly)
- A 29 Antenna Amplifier
- A 30 Auto Wiper ECU
- A 31 Auto Wiper ECU
- A 32 AFS Off SW
  
- B 2 Blower Motor
- B 3 Blower Motor Controller
- B 4 Body ECU
- B 5 Body ECU
- B 6 Body ECU
- B 7 Body ECU
- B 8 Brake Pedal Load Sensing SW
- B 9 Buckle SW (Driver's Side) , Seat Position Airbag Sensor
- B 16 Buckle SW (Front Passenger's Side) , Occupant Detection Sensor

Position of Parts in Instrument Panel <LHD>

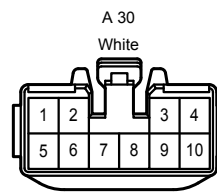
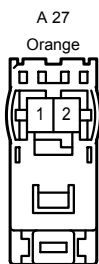
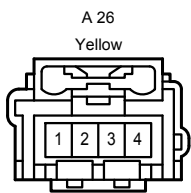
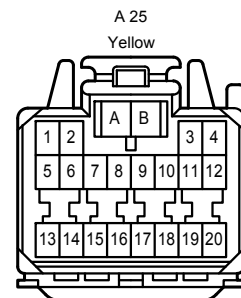
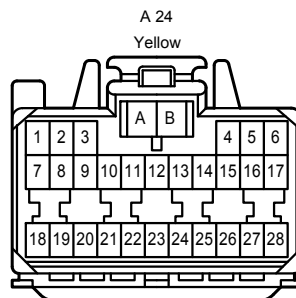
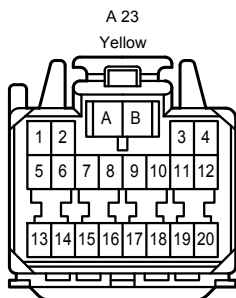
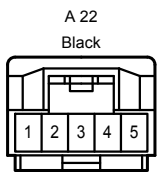
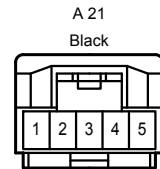
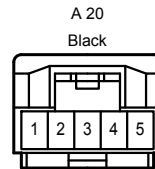
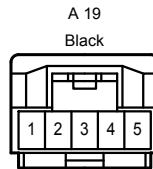
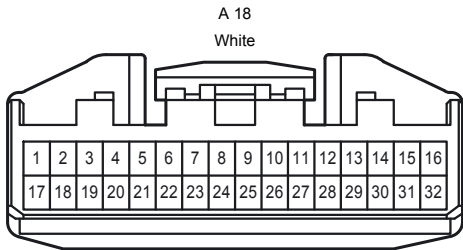
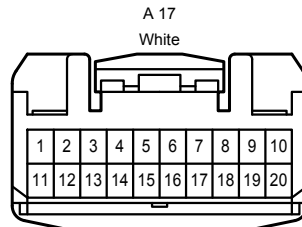
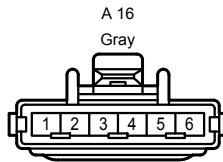
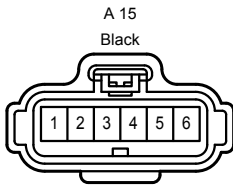
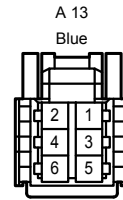
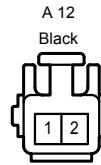
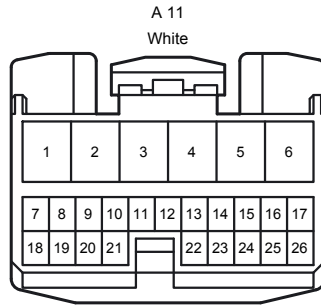
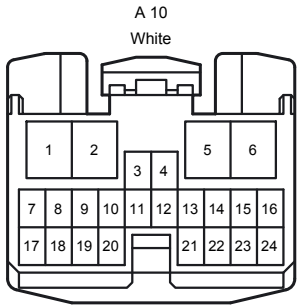

Position of Parts in Instrument Panel <LHD>

